

Mastering CAE Innovation

The Official DEP MeshWorks Training Programme

TRAINING CATALOGUE

2024 v1.0



Transform Your CAE Expertise

Elevate your design capabilities to new heights with industry-leading training that promises unmatched efficiency and mastery in CAE simulation.

Discover the power of DEP MeshWorks and turn engineering challenges into opportunities for innovation.

DEP
MeshWorks

AGENDA

01

Preamble

02

Our courses

03

Calendar

04

Training description sheets

05

Training centre

06

Practical information



PREAMBLE

Unlock CAE Excellence with DEP MeshWorks Training

At Dynas+ Engineering Products, we understand that the core of innovation lies in the power to optimize. Our DEP MeshWorks training is meticulously designed to empower CAE engineers with unparalleled proficiency in the leading-edge software that's shaping the future of engineering design.

Embark on a learning journey that enhances your expertise, streamlines your CAE workflow, and maximizes return on investment.

Efficiency in Learning

Dive into a learning experience crafted for rapid mastery. Our curriculum is structured to expedite your journey from novice to expert, ensuring that every training session delivers a profound impact on your skills and understanding.



Software Superiority

DEP MeshWorks stands at the zenith of CAE solutions, offering an unmatched blend of sophistication and user-friendliness. Our training sessions showcase the software's robust capabilities in meshing, morphing, and CAE workflow acceleration.

ROI for Engineers

Investing in DEP MeshWorks training is an investment in your future. The skills and techniques acquired are not just for immediate project enhancement; they're a career-long asset that will continue to yield returns.

Choose DEP MeshWorks training – where software meets expertise, and potential meets realization.

Dynas+ Engineering Products is the Technical Centre & the official reseller of DEP MeshWorks for the European territory.



Certified DataDock

Registration number of the training organization:

73 31 10135 31



TRAINERS

The speakers of the training sessions are:

- for 90% technical experts from **Dynas+ Engineering Products (DEP EUROPE)**,
- for 10% technical experts from **Detroit Engineered Products (DEP USA)**.

The trainers are having significant experience in DEP MeshWorks and in the production of training sessions. The names of the trainers provided for each training are indicated in the associated descriptive sheet.

ACCESSIBILITY

Our training offer is accessible to everyone, do not hesitate to send us any specific requests in order to best adapt our training methods.

For any information or to register :

✉ training@depeurope.com or ☎ +33 (0)5 61 44 54 98

Our disability referent is Charlotte Michel:

c.michel@dynasplus.com ou ☎ +33 (0)6 33 67 07 58

INTER-company Training

Regularly scheduled sessions that foster **collaborative learning** alongside peers from various organizations. Our comprehensive Training Calendar is your guide to upcoming dates. We're responsive to demand—additional sessions can be arranged to accommodate your needs.



INTRA-company Training

Exclusive training events, scheduled flexibly around your team's availability. Conducted **on-site** at your premises or **at our state-of-the-art training centers**, these sessions ensure a **focused** learning environment tailored to your company.



Customized/Specific Training

Bespoke training **designed around your specific requirements**. Whether at your location or ours, these sessions are molded to address the unique challenges your engineers face.

Remote Training via Videoconference

Our commitment to **accessibility** and **convenience** is embodied in our remote training options. Engage with our experts in **real-time** through WebEx, ensuring an interactive, hands-on learning experience that mirrors our in-person excellence.

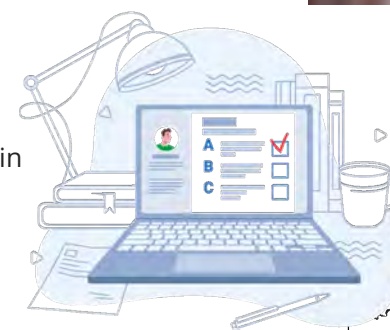

Discover Our Training Centers

Explore our global training locations on the accompanying map, and select the venue that best suits your professional development journey



Feature	INTER-company	INTRA-company	Customized/Specific	Remote via Videoconference
Participants	Up to 8	Up to 6	Tailored to client's needs	Up to 5
Location	Training centers	Client' site or training centers or remote	Client' site or training centers or remote	Any location with internet access
Schedule	Fixed (see Training Calendar)	Flexible (client preference)	Fully customized	Flexible and convenient
Content	Standard curriculum	Standard curriculum	Tailored to client's needs	Standard curriculum or Tailored to client's needs
Interaction	Mixed company participants	Employees from one company only	Direct focus on client's team and goals	Live remote interaction
Resources	Provided by DEP	Provided by client or DEP (depending on the location)	Provided by client or DEP (depending on the location)	Provided by client & software/licenses by DEP
Pricing	Per student	Fixed price for the group	Custom Fixed pricing based on the requirements	Fixed price for the group
Objective	Broad skill enhancement	Team-oriented learning	Specific objectives/targets	Accessible & flexible learning
Benefits	Network with peers, cost-effective	Privacy, convenience	Highly relevant, exclusive focus	Safe, no travel required
Ideal For	Individual growth, small companies	Team building, confidentiality	Specific challenges or projects	International teams, continuous learning

Read full terms and conditions



➤ Interested? Contact us at training@depeurope.com to build together a customized program that best meets your needs.



OUR COURSES

Our mission

More than hundreds of people have already benefited from our expertise and transformed their workflow thanks to our training courses. Our high-quality and certified training courses are designed by several experts, and our pedagogical progression has been thought out to maximize your level up required to achieve your productivity objectives.

Training courses « Basics », « Complementary », « Advanced » and « Specialist »:

Our training courses have been divided into 4 categories depending on the prerequisite and the targeted application cases.

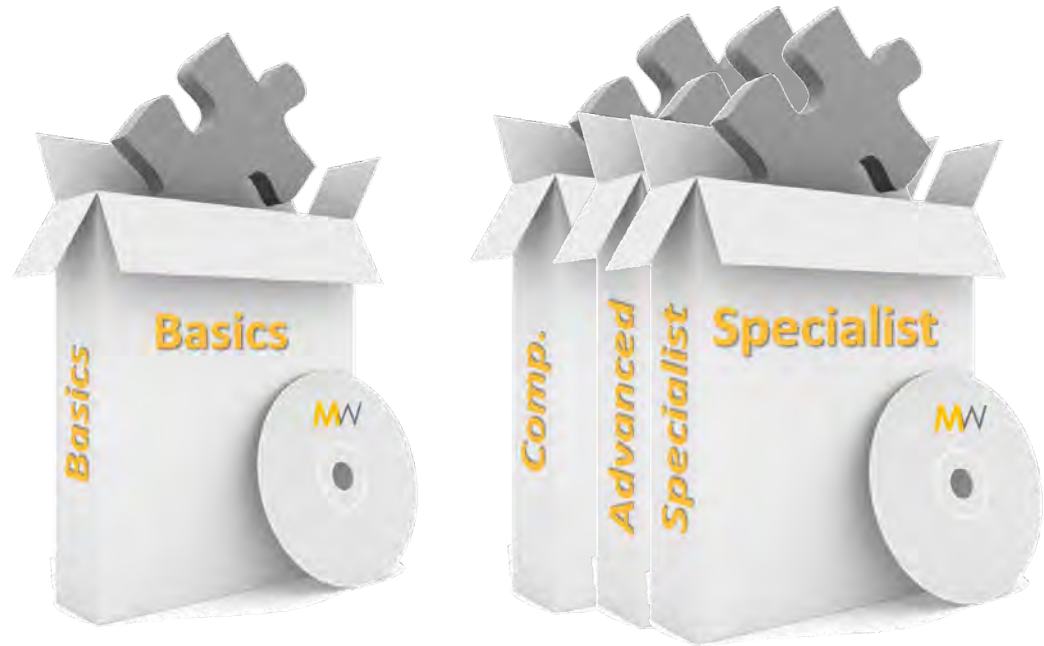
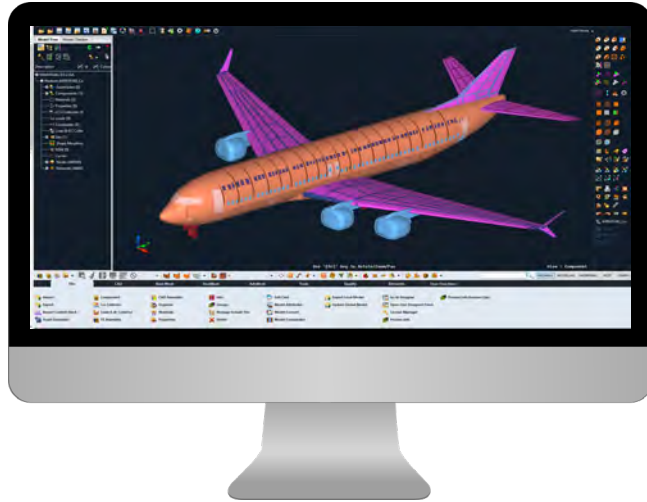









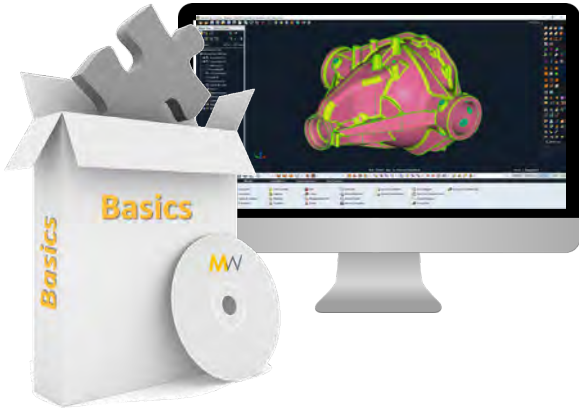







- Interested? Contact us at training@depeurope.com to build together a customized program that best meets your needs.
- All our courses are available in English and French

Training courses « Basics » :



Learn how to use DEP MeshWorks with no prerequisite and how to accelerate your meshing workflow maximizing quality and efficiency.

Depending on your need and application, several course options are available:



BAS-01Q	DEP MeshWorks Essentials with QUAD Meshing Focus		3 days	
BAS-01H	DEP MeshWorks Essentials with HEXA Meshing Focus		3 days	
BAS-01T	DEP MeshWorks Essentials with TETRA Meshing Focus		3 days	
BAS-02	DEP MeshWorks Essentials with CFD Meshing Focus		3 days	
BAS-03	DEP MeshWorks Essentials: Comprehensive Meshing Techniques		Best Seller	4 days 
BAS-04Q	Proficient Transition to DEP MeshWorks: Accelerated QUAD Meshing		1 day	
BAS-04H	Proficient Transition to DEP MeshWorks: Accelerated HEXA Meshing		2 days	
BAS-04T	Proficient Transition to DEP MeshWorks: Accelerated TETRA Meshing		1 day	









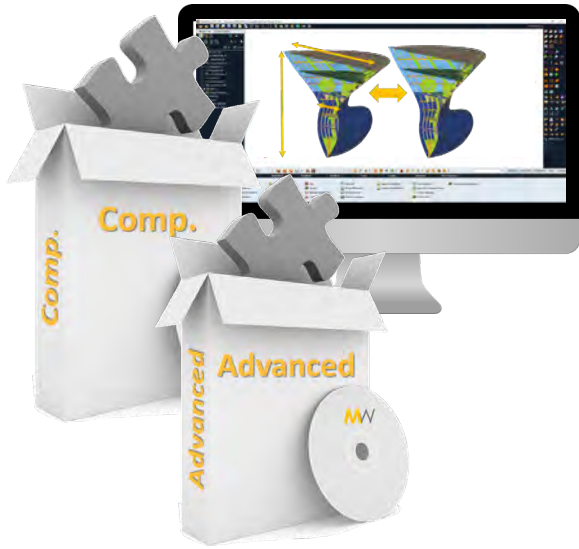



**Training
description sheets**

 **Already planned in the calendar**
 **To be planned according to request**

Training courses « Complementary » & « Advanced » :

Learn how to use complementary added-value applications of DEP MeshWorks with the Basics prerequisite.



COMP-01	PRE -Processing: Multi-Solver Integration and Efficient Assembly 	0.5 day 
COMP-02	POST -Processing Proficiency: Enhancing Design Analysis 	0.5 day 
COMP-03	Accelerating CAE Workflow: Morphing Techniques  Best Seller	1 day 
ADV-01	Transformative CAD Morphing workflow 	0.5 day 
ADV-02	Efficiency through Process Automation : Streamlining CAE workflows 	3 days 
ADV-03	Bridging with LS-OPT Software for Optimized Design 	0.5 day 

Training
description sheets















Already planned in the calendar

To be planned according to request

Training courses « Specialist » :

Learn how to use specialist technologies of DEP MeshWorks with the Complementary or Advanced prerequisite.



- | | | |
|---------------|---|---|
| SPE-01 | ConceptWorks – Revolutionizing Sheet Metal Design  | 1 day  |
| SPE-02 | ConceptWorks Plastics – Automated Design Innovations  | 0.5 day  |
| SPE-03 | Full Vehicle Morphing Mastery: Redefining Vehicle Design  |  |
| SPE-04 | Advanced Tire HEXA Meshing : Accelerating Tire Design  | 1 day  |
| SPE-05 | Advanced Automated Features for Body, Chassis & Subframe  | 1 day  |
| SPE-06 | Powertrain Engineering: Advanced Automation Techniques  | 2 days  |

[Training description sheets](#)

 To be planned according to request

ALL in one training course, order one our best selling package to level up on DEP MeshWorks:

Our best selling package contains:

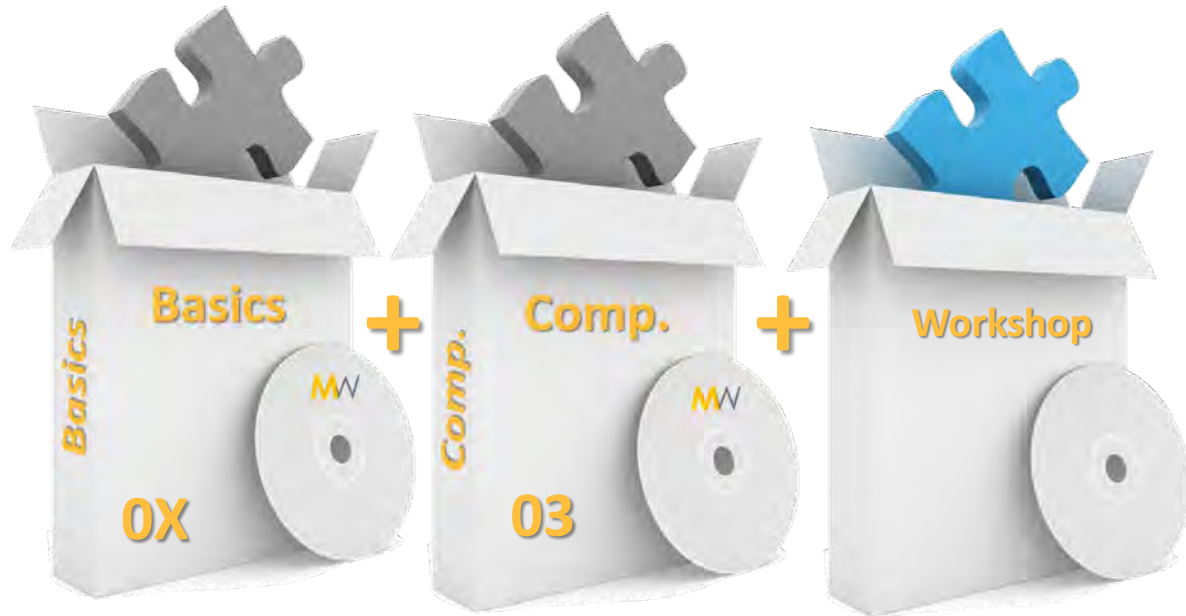

Best Seller

BAS-0X
+
COMP-03
+
Customized
workshop

DEP MeshWorks Essentials
+
CAE Morphing methodologies transforming your workflow
+
A customized workshop on your application!

➤ Interested? Contact us at training@depeurope.com to build together a customized program that best meets your needs.



CALENDAR

JANUARY

15	M	Week n°3 BAS-03 DEP MeshWorks Essentials: Comprehensive Meshing Techniques	
16	T		
17	W		
18	T		
19	F	COMP-03 CAE Morphing	

FEBRUARY

29	M	Week n°5		
30	T			5
31	W			
1	T	BAS-04H Transition to MeshWorks: HEXA Meshing		
2	F			

MARCH

18	M	Week n°12	
19	T		
20	W	BAS-04Q Transition to MeshWorks: QUAD Meshing	
21	T	BAS-04T Transition to MeshWorks: TETRA Meshing	
22	F		

JULY

1	M	Week n°27 BAS-03 DEP MeshWorks Essentials: Comprehensive Meshing Techniques		
2	T			
3	W			
4	T			
5	F		COMP-03 CAE Morphing	
8	M	Week n°28		
9	T			28
10	W		BAS-04Q Transition to MeshWorks: QUAD Meshing	
11	T		BAS-04T Transition to MeshWorks: TETRA Meshing	
12	F			

AUGUST

☀️
SUMMER BREAK

SEPTEMBER

ONLY ON REQUEST

APRIL

ONLY ON REQUEST

MAY

13	M	Week n°20		
14	T			
15	W		BAS-04H Transition to MeshWorks: HEXA Meshing	
16	T			
17	F			
27	M	Week n°22 BAS-03 DEP MeshWorks Essentials: Comprehensive Meshing Techniques		
28	T			
29	W			
30	T			
31	F		COMP-03 CAE Morphing	

JUNE

ONLY ON REQUEST

OCTOBER

7	M	Week n°41 BAS-03 DEP MeshWorks Essentials: Comprehensive Meshing Techniques		
8	T			
9	W			
10	T			
11	F		COMP-03 CAE Morphing	
14	M	Week n°42		
15	T			
16	W		BAS-04H Transition to MeshWorks: HEXA Meshing	
17	T			
18	F			

NOVEMBER

11	M	Week n°46 Armistice 1918	
12	T		
13	W	BAS-04Q Transition to MeshWorks: QUAD Meshing	
14	T	BAS-04T Transition to MeshWorks: TETRA Meshing	
15	F		

DECEMBER

ONLY ON REQUEST

Last update : 01/30/2024



TRAINING DESCRIPTION SHEETS

Check out the program!

- Each course offers a step-by-step procedure developed by experts, to give you the strategies you need to succeed.
- Our courses aren't just theoretical training, but also the practical application of the strategies taught.
- The educational program is improved on a yearly-basis based on all the feedback shared by the past trainees

BAS-01Q DEP MeshWorks Essentials with QUAD Meshing Focus



Course overview

1. Software Exploration
2. Interactive Mesh Generation
3. Template-Driven Mesh Generation
4. Mesh Quality Excellence
5. Advanced QUAD Meshing Techniques

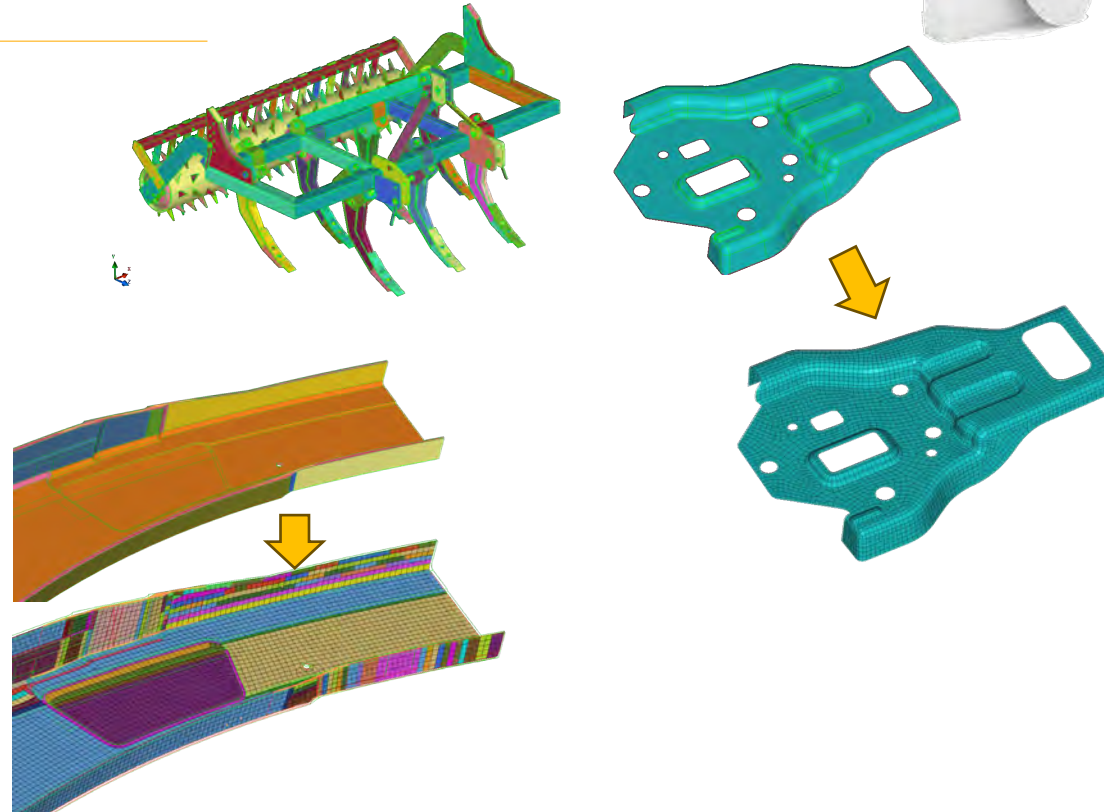

TARGETED AUDIENCE

- CAD / CAE engineers wishing to:
- start using DEP MeshWorks from scratch
 - learn how to do QUAD meshing.



PREREQUISITE

Basic familiarity with CAE concepts and interest in Meshing.



DURATION

3 days (6 x 3.5 hours)



TRAINERS



MAIN OBJECTIVE

- ✓ Equip trainees with a robust understanding of DEP MeshWorks, focusing on mastering QUAD meshing capabilities to enhance modeling efficiency.

PEDAGOGICAL OBJECTIVES

- ✓ **Interface Proficiency:** Gain proficiency in navigating the DEP MeshWorks interface and manipulating model views with confidence for optimal visualization and analysis.
- ✓ **Geometry Optimization:** Acquire the ability to meticulously clean and simplify both CAD and FE geometries, laying the groundwork for high-quality mesh generation.
- ✓ **Surface Meshing Techniques:** Develop hands-on skills to manually mesh surfaces with surface elements, ensuring a strong foundation in mesh creation.
- ✓ **Template Management:** Learn to design, implement, and manage custom mesh templates, leveraging automation to accelerate the meshing process without the need for constant user interaction.
- ✓ **Mesh Modification and Quality Control:** Become adept at interactively modifying meshes and employing advanced techniques to control and enhance mesh quality.
- ✓ **Critical Thinking in Mesh Workflow:** Cultivate the ability to critically assess and choose the appropriate meshing strategies for varied project requirements
- ✓ **QUAD Mesh Excellence:** Achieve the skill to generate full quad meshes, optimizing mesh flow and topology to meet the rigorous demands of complex simulations.

BAS-01Q DEP MeshWorks Essentials with QUAD Meshing Focus

Course detailed content

1. Software Exploration

- ✓ Global presentation
- ✓ Reminder CAE Fundamentals
- ✓ Why DEP MeshWorks
- ✓ Some real-world applications
- ✓ Intuitive Interface overview
- ✓ Software hands-on

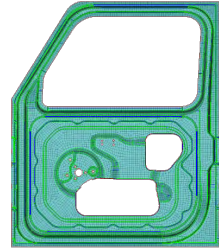

2. Interactive Mesh Generation

- ✓ CAD Cleaning & Simplification
- ✓ CAD Modification
- ✓ Various meshing engines & Algorithms
- ✓ Mesh/FE Modifications

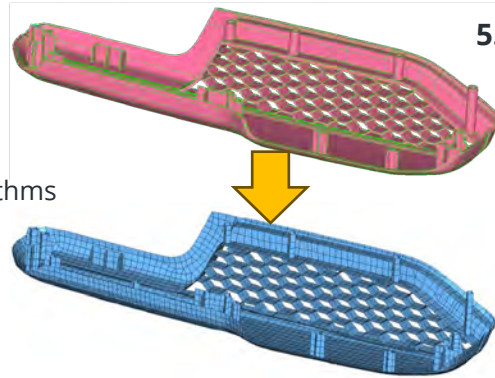

3. Template-Driven Mesh Generation

- ✓ Templates creation
- ✓ Templates management
- ✓ Best Practices

4. Mesh Quality Excellence

- ✓ Quality checking & visualization tools
- ✓ Auto Quality Correction & Improvement
- ✓ Quick Interactive Quality Correction
- ✓ Thickness Assignment
- ✓ Normal alignment

5. Advanced QUAD Meshing Techniques

- ✓ QUAD Workflow: step-by-step approach
- ✓ Interactive remeshing
- ✓ Professional Tips

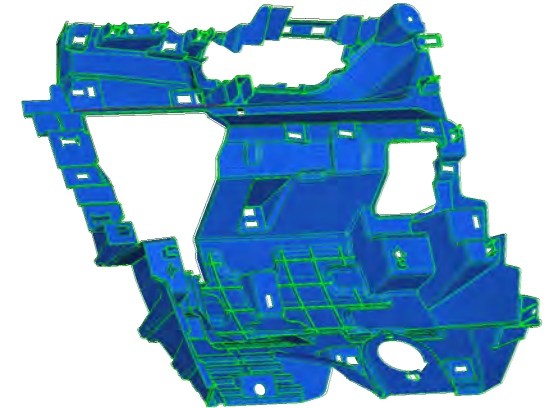
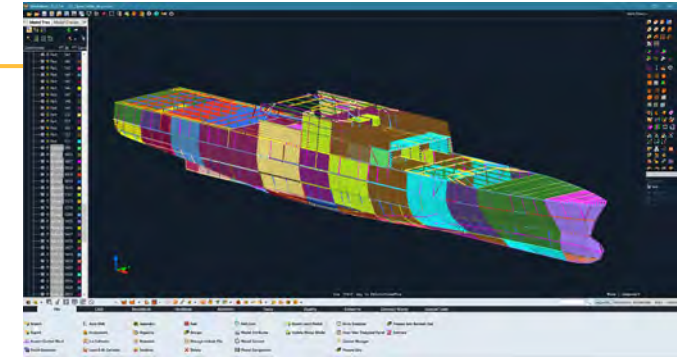

The key concepts of the training are illustrated with practical exercises.

- Embark on a journey to discover the integral aspects of QUAD meshing in 'DEP MeshWorks Essentials with QUAD Meshing Focus.'
- This comprehensive course provides a deep dive into the intuitive world of DEP MeshWorks, combining a thorough overview of the software with practical hands-on experience. Engage in learning the core principles of CAD cleaning, simplification, and modification, and explore various surface meshing engines and algorithms.
- You'll gain expertise in template-driven mesh generation and uncover the best practices for ensuring mesh quality excellence. The course culminates in advanced QUAD meshing techniques, where you'll learn step-by-step workflows and receive professional tips for mastering QUAD meshing.
- Designed for engineers focused on precision and efficiency, this course is a gateway to mastering QUAD meshing in DEP MeshWorks.

BAS-01H DEP MeshWorks Essentials with HEXA Meshing Focus

Course overview

1. Software Exploration
2. Interactive Mesh Generation
3. Mesh Quality Excellence
4. Advanced HEXA Meshing Techniques

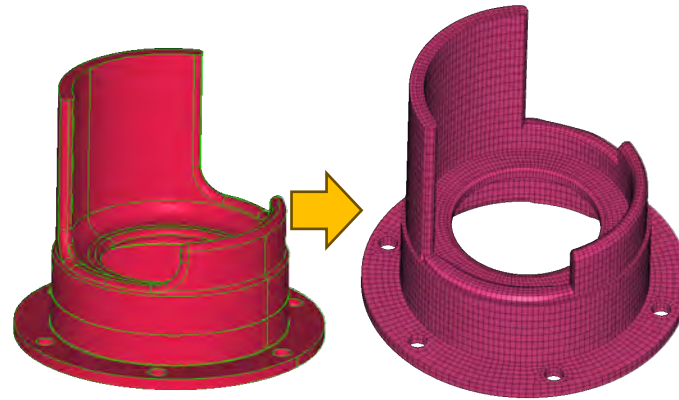
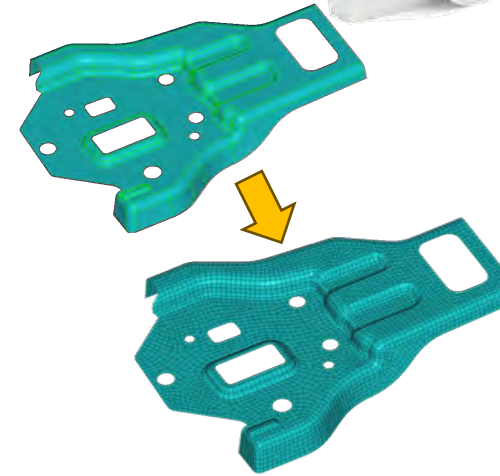
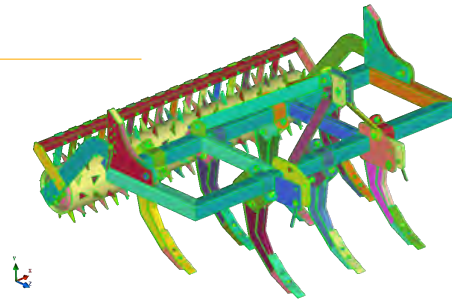

TARGETED AUDIENCE

- CAD / CAE engineers wishing to:
- start using DEP MeshWorks from scratch
 - learn how to do HEXA meshing.



PREREQUISITE

Basic familiarity with CAE concepts and interest in Meshing.



DURATION

3 days (6 x 3.5 hours)



TRAINERS



MAIN OBJECTIVE

- ✓ Equip trainees with a robust understanding of DEP MeshWorks, focusing on mastering HEXA meshing capabilities to enhance modeling efficiency.

PEDAGOGICAL OBJECTIVES

- ✓ **Interface Proficiency:** Gain proficiency in navigating the DEP MeshWorks interface and manipulating model views with confidence for optimal visualization and analysis.
- ✓ **Geometry Optimization:** Acquire the ability to meticulously clean and simplify both CAD and FE geometries, laying the groundwork for high-quality mesh generation.
- ✓ **Surface Meshing Techniques:** Develop hands-on skills to manually mesh surfaces with surface elements, ensuring a strong foundation in mesh creation.
- ✓ **Mesh Modification and Quality Control:** Become adept at interactively modifying meshes and employing advanced techniques to control and enhance mesh quality.
- ✓ **Critical Thinking in Mesh Workflow:** Cultivate the ability to critically assess and choose the appropriate meshing strategies for varied project requirements.
- ✓ **HEXA Mesh Excellence:** Achieve the skill to generate full hexa meshes, optimizing mesh flow and topology to meet the rigorous demands of complex simulations.

BAS-01H DEP MeshWorks Essentials with HEXA Meshing Focus

Course detailed content

1. Software Exploration

- ✓ Global presentation
- ✓ Reminder CAE Fundamentals
- ✓ Why DEP MeshWorks
- ✓ Some real-world applications
- ✓ Intuitive Interface overview
- ✓ Software hands-on

2. Interactive Mesh Generation

- ✓ CAD Cleaning & Simplification
- ✓ CAD Modification
- ✓ Various meshing engines & Algorithms
- ✓ Mesh/FE Modifications

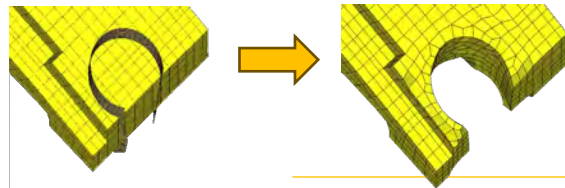

3. Mesh Quality Excellence

- ✓ Quality checking & visualization tools
- ✓ Auto Quality Correction & Improvement
- ✓ Quick Interactive Quality Correction
- ✓ Thickness assignment
- ✓ Normal alignment

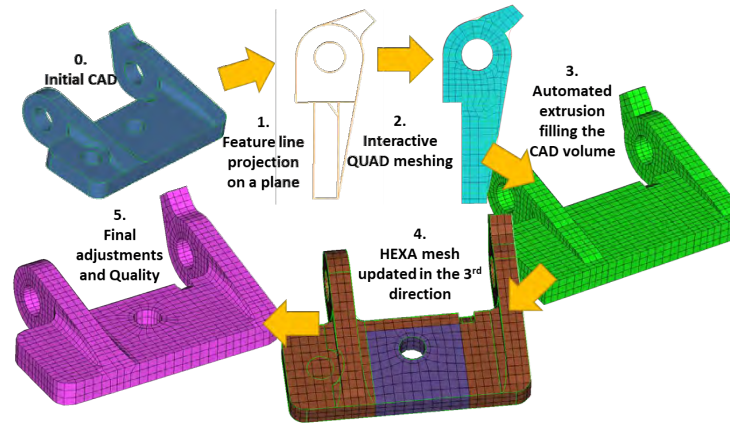

4. Advanced HEXA Meshing Techniques

- ✓ HEXA meshing strategies
- ✓ Extruded 3D Mesh Generation Tools
- ✓ Semi-automated HEXA Meshing Workflow
- ✓ Automated Tools for Update
- ✓ Interactive Modification & Useful Tips

The key concepts of the training are illustrated with practical exercises.

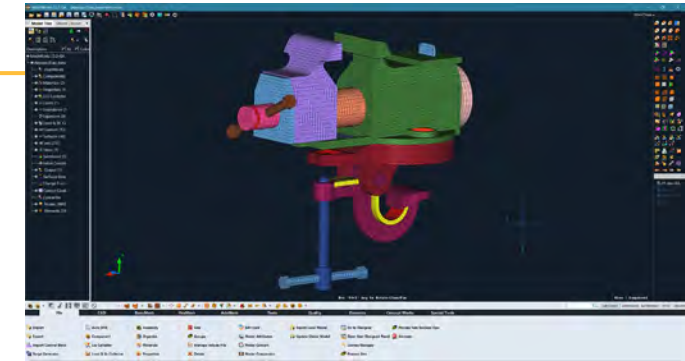

- Embark on a journey to discover the integral aspects of HEXA meshing in 'DEP MeshWorks Essentials with HEXA Meshing Focus.'
- This comprehensive course provides a deep dive into the intuitive world of DEP MeshWorks, combining a thorough overview of the software with practical hands-on experience. Engage in learning the core principles of CAD cleaning, simplification, and modification, and explore various surface meshing engines and algorithms.
- You'll gain expertise in template-driven mesh generation and uncover the best practices for ensuring mesh quality excellence. The course culminates in advanced HEXA meshing techniques, where you'll learn step-by-step workflows and receive professional tips for mastering HEXA meshing.
- Designed for engineers focused on precision and efficiency, this course is a gateway to mastering HEXA meshing in DEP MeshWorks.

BAS-01T DEP MeshWorks Essentials with TETRA Meshing Focus



Course overview

1. Software Exploration
2. Interactive Mesh Generation
3. Template-Driven Mesh Generation
4. Mesh Quality Excellence
5. Advanced TETRA Meshing Techniques

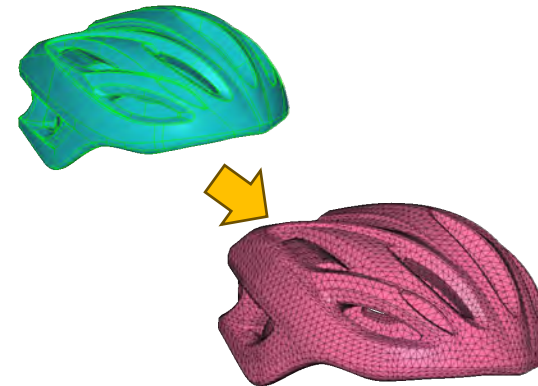
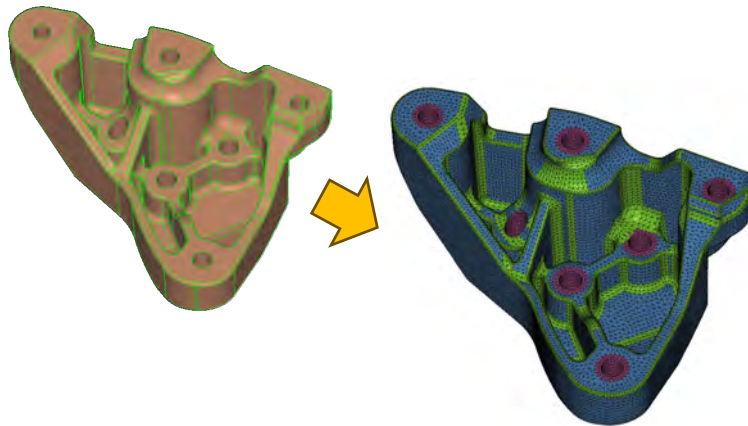
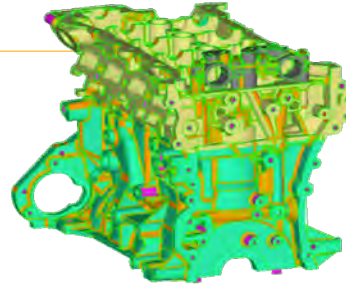

TARGETED AUDIENCE

- CAD / CAE engineers wishing to:
- start using DEP MeshWorks from scratch
 - learn how to do TETRA meshing.



PREREQUISITE

Basic familiarity with CAE concepts and interest in Meshing.



DURATION

3 days (6 x 3.5 hours)



TRAINERS



MAIN OBJECTIVE

- ✓ Equip trainees with a robust understanding of DEP MeshWorks, focusing on mastering TETRA meshing capabilities to enhance modeling efficiency.

PEDAGOGICAL OBJECTIVES

- ✓ **Interface Proficiency:** Gain proficiency in navigating the DEP MeshWorks interface and manipulating model views with confidence for optimal visualization and analysis.
- ✓ **Geometry Optimization:** Acquire the ability to meticulously clean and simplify both CAD and FE geometries, laying the groundwork for high-quality mesh generation.
- ✓ **Surface Meshing Techniques:** Develop hands-on skills to manually mesh surfaces with surface elements, ensuring a strong foundation in mesh creation.
- ✓ **Template Management:** Learn to design, implement, and manage custom mesh templates, leveraging automation to accelerate the meshing process without the need for constant user interaction.
- ✓ **Mesh Modification and Quality Control:** Become adept at interactively modifying meshes and employing advanced techniques to control and enhance mesh quality.
- ✓ **Critical Thinking in Mesh Workflow:** Cultivate the ability to critically assess and choose the appropriate meshing strategies for varied project requirements.
- ✓ **TETRA Mesh Excellence:** Achieve the skill to generate full tetra meshes, optimizing mesh flow and topology to meet the rigorous demands of complex simulations.

BAS-01T DEP MeshWorks Essentials with TETRA Meshing Focus

Course detailed content

1. Software Exploration

- ✓ Global presentation
- ✓ Reminder CAE Fundamentals
- ✓ Why DEP MeshWorks
- ✓ Some real-world applications
- ✓ Intuitive Interface overview
- ✓ Software hands-on

2. Interactive Mesh Generation

- ✓ CAD Cleaning & Simplification
- ✓ CAD Modification
- ✓ Various meshing engines & Algorithms
- ✓ Mesh/FE Modifications

3. Template-Driven Mesh Generation

- ✓ Templates creation
- ✓ Templates management
- ✓ Best Practices

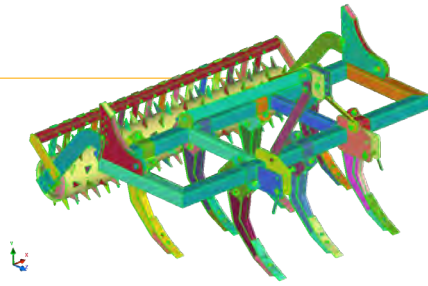

4. Mesh Quality Excellence

- ✓ Quality checking & visualization tools
- ✓ Auto Quality Correction & Improvement
- ✓ Quick Interactive Quality Correction
- ✓ Thickness assignment
- ✓ Normal alignment

5. Advanced TETRA Meshing Techniques

- ✓ TETRA Workflow: step-by-step approach
- ✓ Interactive remeshing
- ✓ Professional Tips

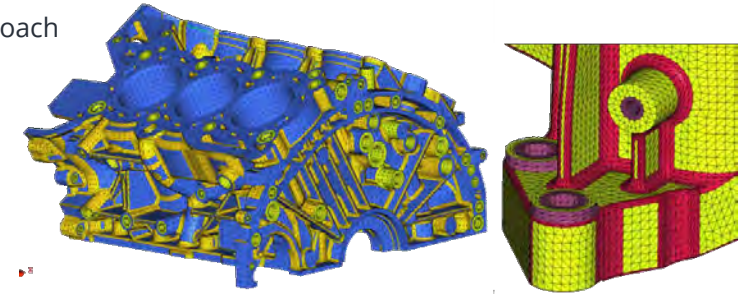
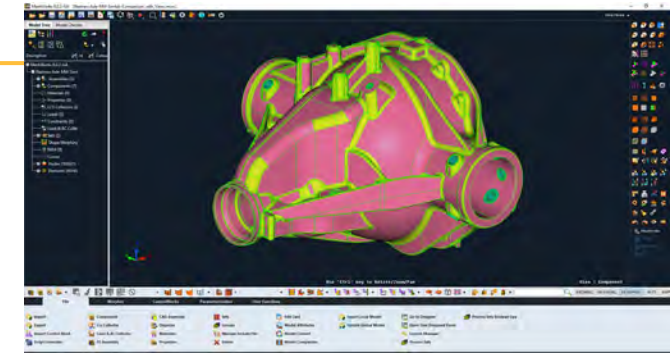
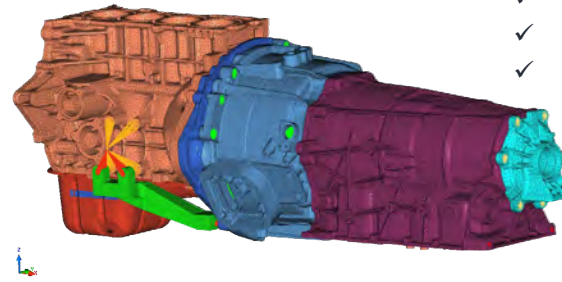

The key concepts of the training are illustrated with practical exercises.

- Embark on a journey to discover the integral aspects of TETRA meshing in 'DEP MeshWorks Essentials with TETRA Meshing Focus.'
- This comprehensive course provides a deep dive into the intuitive world of DEP MeshWorks, combining a thorough overview of the software with practical hands-on experience. Engage in learning the core principles of CAD cleaning, simplification, and modification, and explore various surface meshing engines and algorithms.
- You'll gain expertise in template-driven mesh generation and uncover the best practices for ensuring mesh quality excellence. The course culminates in advanced TETRA meshing techniques, where you'll learn step-by-step workflows and receive professional tips for mastering TETRA meshing.
- Designed for engineers focused on precision and efficiency, this course is a gateway to mastering TETRA meshing in DEP MeshWorks.

BAS-02 DEP MeshWorks Essentials with CFD Meshing Focus



Course overview

1. Software Exploration
2. Interactive Mesh Generation
3. Template-Driven Mesh Generation
4. Mesh Quality Excellence
5. Advanced Surface Meshing Techniques

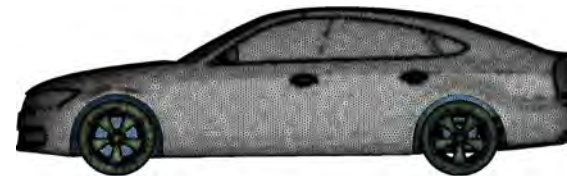
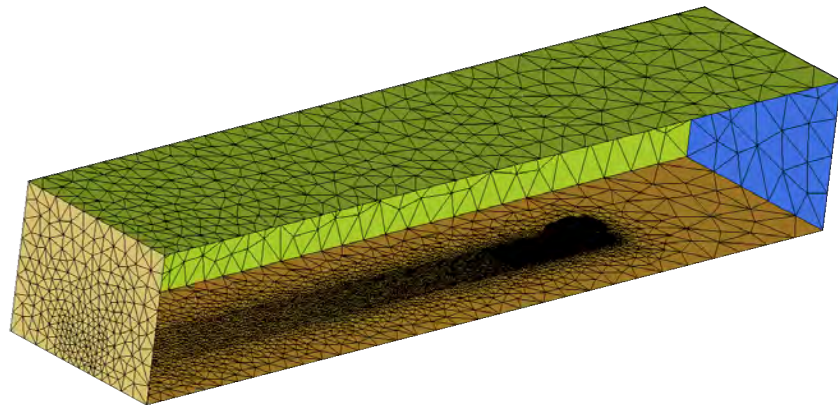

MAIN OBJECTIVE

- ✓ Equip trainees with a robust understanding of DEP MeshWorks, focusing on mastering surface meshing capabilities for CFD applications.

PEDAGOGICAL OBJECTIVES

- ✓ **Interface Proficiency:** Gain proficiency in navigating the DEP MeshWorks interface and manipulating model views with confidence for optimal visualization and analysis.
- ✓ **Geometry Optimization:** Acquire the ability to meticulously clean and simplify both CAD and FE geometries, laying the groundwork for high-quality mesh generation.
- ✓ **Surface Meshing Techniques:** Develop hands-on skills to manually mesh surfaces with surface elements, ensuring a strong foundation in mesh creation.
- ✓ **Template Management:** Learn to design, implement, and manage custom mesh templates, leveraging automation to accelerate the meshing process without the need for constant user interaction.
- ✓ **Mesh Modification and Quality Control:** Become adept at interactively modifying meshes and employing advanced techniques to control and enhance mesh quality.
- ✓ **Critical Thinking in Mesh Workflow:** Cultivate the ability to critically assess and choose the appropriate meshing strategies for varied project requirements.
- ✓ **Wetted Surface Mesh Excellence:** Achieve the skill to generate wetted surface meshes, optimizing topology to meet the rigorous demands of complex CFD simulations.



TARGETED AUDIENCE

- CAD / CAE engineers wishing to:
- start using DEP MeshWorks from scratch
 - learn how to do surface meshing for CFD.



PREREQUISITE

Basic familiarity with CAE concepts and interest in Meshing.



DURATION

3 days (6 x 3.5 hours)



TRAINERS



BAS-02 DEP MeshWorks Essentials with CFD Meshing Focus

Course detailed content

1. Software Exploration

- ✓ Global presentation
- ✓ Reminder CAE Fundamentals
- ✓ Why DEP MeshWorks
- ✓ Some real-world applications
- ✓ Intuitive Interface overview
- ✓ Software hands-on

2. Interactive Mesh Generation

- ✓ CAD Cleaning & Simplification
- ✓ CAD Modification
- ✓ Various meshing engines & Algorithms
- ✓ Mesh/FE Modifications

3. Template-Driven Mesh Generation

- ✓ Templates creation
- ✓ Templates management
- ✓ Best Practices

4. Mesh Quality Excellence

- ✓ Quality checking & visualization tools
- ✓ Auto Quality Correction & Improvement
- ✓ Quick Interactive Quality Correction
- ✓ Thickness Assignment
- ✓ Normal alignment

5. Advanced Surface Meshing Techniques

- ✓ CFD Workflow: step-by-step approach
- ✓ Wetted surface creation
- ✓ Professional Tips

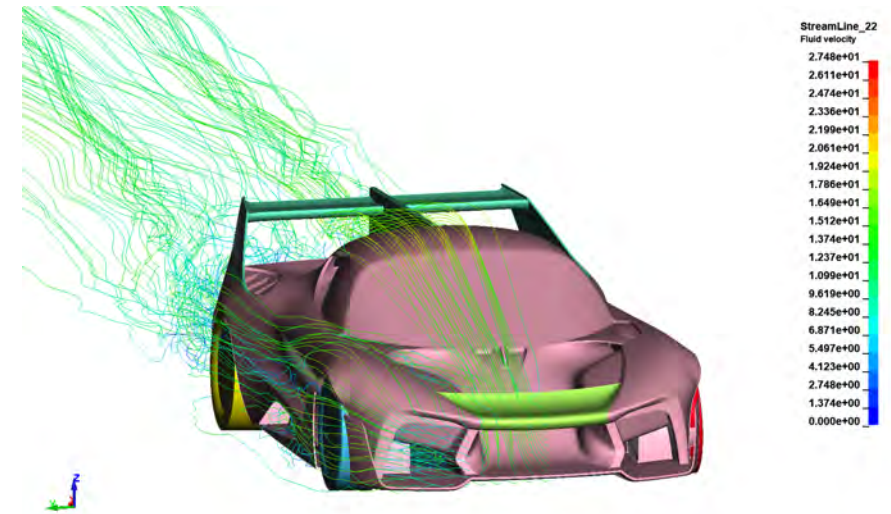

The key concepts of the training are illustrated with practical exercises.

- Embark on a journey to discover the integral aspects of surface meshing in 'DEP MeshWorks Essentials with CFD Meshing Focus.'
- This comprehensive course provides a deep dive into the intuitive world of DEP MeshWorks, combining a thorough overview of the software with practical hands-on experience. Engage in learning the core principles of CAD cleaning, simplification, and modification, and explore various surface meshing engines and algorithms.
- You'll gain expertise in template-driven mesh generation and uncover the best practices for ensuring mesh quality excellence. The course culminates in advanced Surface meshing techniques, where you'll learn step-by-step workflows and receive professional tips for mastering CFD wetted surface meshing.
- Designed for engineers focused on precision and efficiency, this course is a gateway to mastering CFD meshing in DEP MeshWorks.

BAS-03 DEP MeshWorks Essentials: Comprehensive Meshing Techniques



Course overview

1. Software Exploration
2. Interactive Mesh Generation
3. Template-Driven Mesh Generation
4. Mesh Quality Excellence
5. Advanced QUAD Meshing Techniques
6. Advanced HEXA Meshing Techniques
7. Advanced TETRA Meshing Techniques

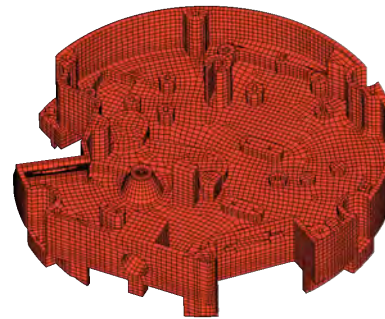
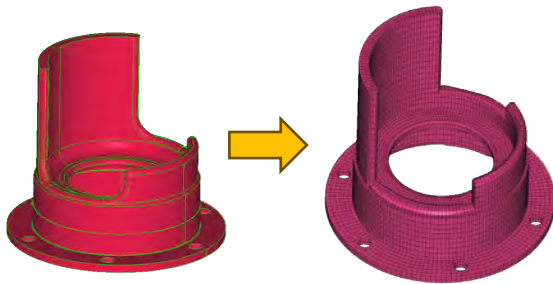
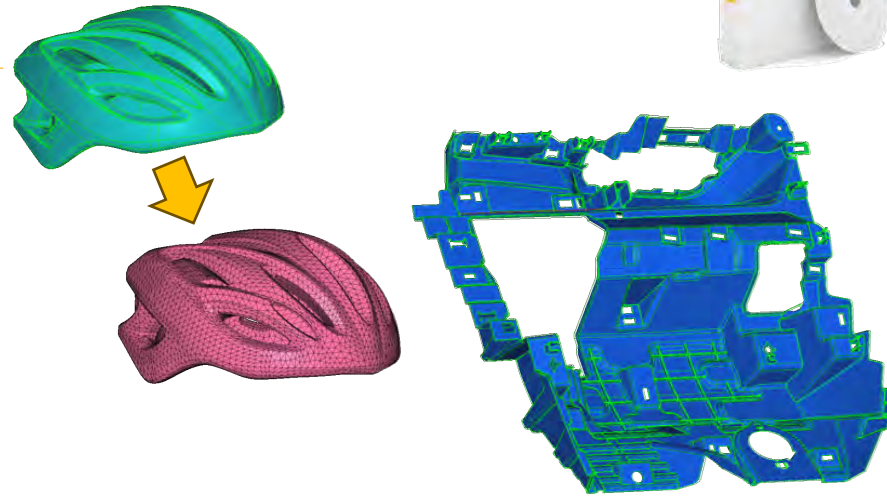

TARGETED AUDIENCE

- CAD / CAE engineers wishing to:
- start using DEP MeshWorks from scratch
 - learn how to do QUAD, HEXA & TETRA meshing.



PREREQUISITE

Basic familiarity with CAE concepts and interest in Meshing.



DURATION

4 days (8 x 3.5 hours)



TRAINERS



MAIN OBJECTIVE

- ✓ Equip trainees with a robust understanding of DEP MeshWorks, focusing on mastering QUAD, HEXA & TETRA meshing capabilities to enhance modeling efficiency.

PEDAGOGICAL OBJECTIVES

- ✓ **Interface Proficiency:** Gain proficiency in navigating the DEP MeshWorks interface and manipulating model views with confidence for optimal visualization and analysis.
- ✓ **Geometry Optimization:** Acquire the ability to meticulously clean and simplify both CAD and FE geometries, laying the groundwork for high-quality mesh generation.
- ✓ **Surface Meshing Techniques:** Develop hands-on skills to manually mesh surfaces with surface elements, ensuring a strong foundation in mesh creation.
- ✓ **Template Management:** Learn to design, implement, and manage custom mesh templates, leveraging automation to accelerate the meshing process without the need for constant user interaction.
- ✓ **Mesh Modification and Quality Control:** Become adept at interactively modifying meshes and employing advanced techniques to control and enhance mesh quality.
- ✓ **Critical Thinking in Mesh Workflow:** Cultivate the ability to critically assess and choose the appropriate meshing strategies for varied project requirements
- ✓ **Mesh Excellence:** Achieve the skill to generate full structural type meshes, optimizing mesh flow and topology to meet the rigorous demands of complex simulations.

BAS-03 DEP MeshWorks Essentials: Comprehensive Meshing Techniques

Course detailed content

1. Software Exploration

- ✓ Global presentation
- ✓ Reminder CAE Fundamentals
- ✓ Why DEP MeshWorks
- ✓ Some real-world applications
- ✓ Intuitive Interface overview
- ✓ Software hands-on

2. Interactive Mesh Generation

- ✓ CAD Cleaning & Simplification
- ✓ CAD Modification
- ✓ Various meshing engines & Algorithms
- ✓ Mesh/FE Modifications

3. Template-Driven Mesh Generation

- ✓ Templates creation
- ✓ Templates management
- ✓ Best Practices

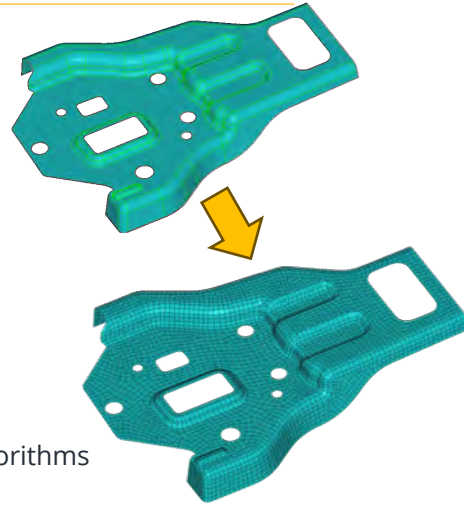

4. Mesh Quality Excellence

- ✓ Quality checking & visualization tools
- ✓ Auto Quality Correction & Improvement
- ✓ Quick Interactive Quality Correction
- ✓ Thickness Assignment
- ✓ Normal alignment

5. Advanced QUAD Meshing Techniques

- ✓ QUAD Workflow: step-by-step approach
- ✓ Interactive remeshing
- ✓ Professional Tips

6. Advanced HEXA Meshing Techniques

- ✓ HEXA meshing strategies
- ✓ Extruded 3D Mesh Generation Tools
- ✓ Semi-automated HEXA Meshing Workflow
- ✓ Automated Tools for Update
- ✓ Interactive Modification & Useful Tips

7. Advanced TETRA Meshing Techniques

- ✓ TETRA Workflow: step-by-step approach
- ✓ Interactive remeshing
- ✓ Professional Tips

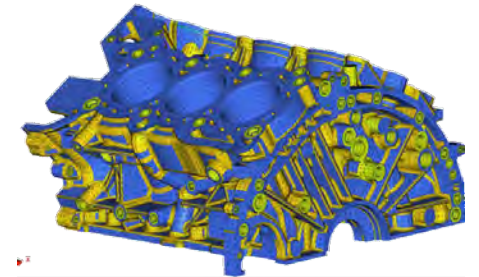
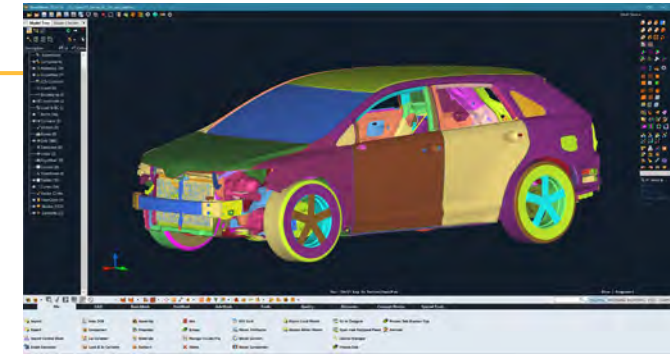

The key concepts of the training are illustrated with practical exercises.

- Embark on a journey to discover the integral aspects of meshing for structural parts in 'DEP MeshWorks Essential: Comprehensive Meshing Techniques.'
- This comprehensive course provides a deep dive into the intuitive world of DEP MeshWorks, combining a thorough overview of the software with practical hands-on experience. Engage in learning the core principles of CAD cleaning, simplification, and modification, and explore various surface meshing engines and algorithms.
- You'll gain expertise in template-driven mesh generation and uncover the best practices for ensuring mesh quality excellence. The course culminates in 3 different advanced parts: QUAD meshing techniques, HEXA meshing techniques and TETRA meshing techniques. In each of those modules, you'll learn step-by-step workflows and receive professional tips for mastering meshing.
- Designed for engineers focused on precision and efficiency, this course is a gateway to mastering meshing in DEP MeshWorks.

BAS-04Q Proficient Transition to DEP MeshWorks: Accelerated QUAD Meshing

Course overview

1. Accelerated Software Introduction
2. Essential Mesh Techniques
3. Advanced QUAD Meshing

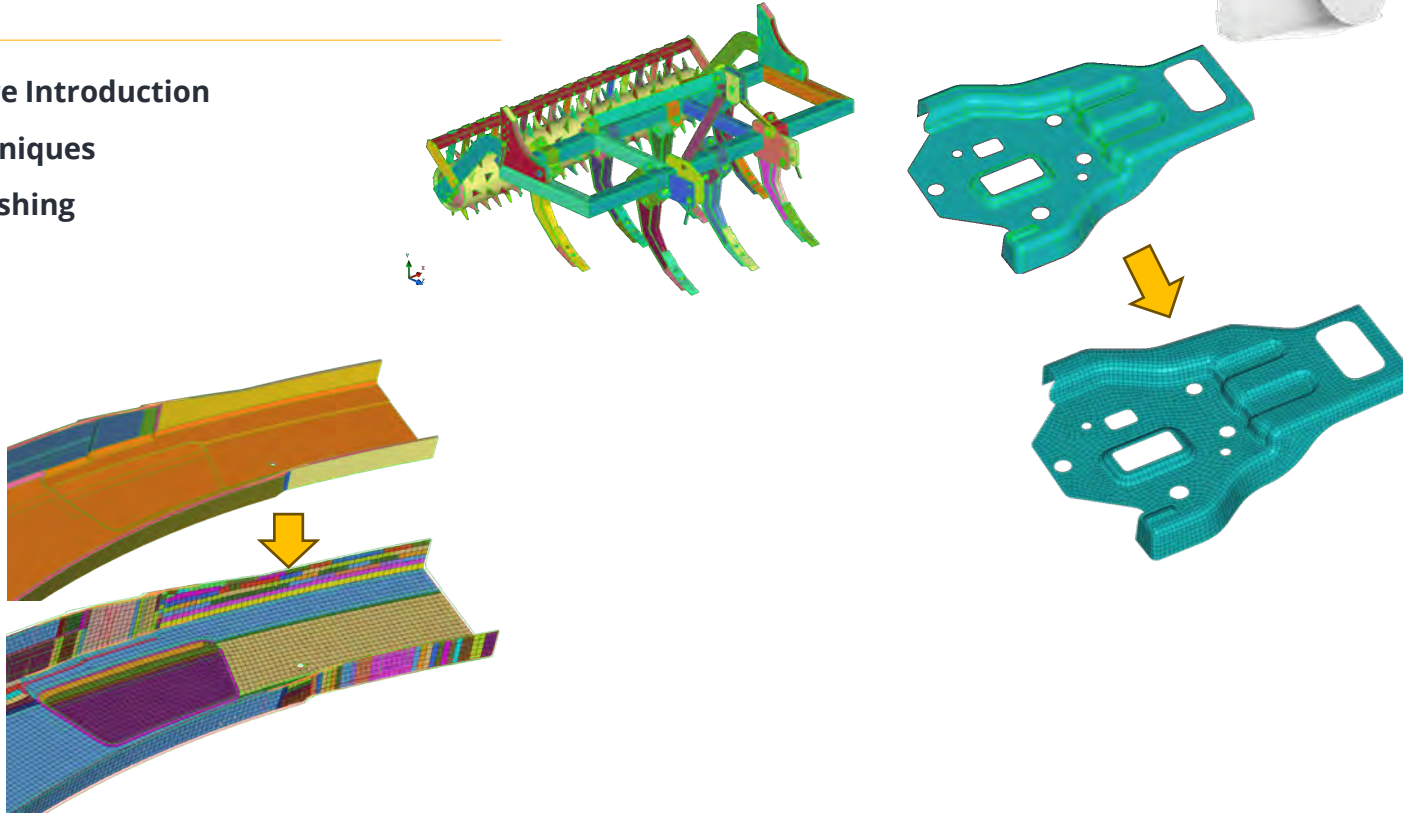

TARGETED AUDIENCE

CAD / CAE engineers wishing to:

- learn how to do QUAD meshing using DEP MeshWorks

PREREQUISITE

Operational proficiency in CAD cleaning and meshing with HyperMesh experience.

DURATION

1 day (2 x 3.5 hours)

TRAINERS



MAIN OBJECTIVE

- ✓ Equip trainees with the skills to seamlessly transition their meshing expertise to DEP MeshWorks, emphasizing a swift mastery of QUAD meshing capabilities.

PEDAGOGICAL OBJECTIVES

- ✓ **Seamless Transition to DEP MeshWorks:** Acquire the ability to efficiently transition existing meshing skills to DEP MeshWorks, with a focus on understanding its unique interface and functionalities.
- ✓ **Advanced Meshing Techniques Adaptation:** Master the adaptation of advanced surface and QUAD meshing techniques to DEP MeshWorks' environment, ensuring a smooth transfer of expertise.
- ✓ **Optimized Geometry Handling in DEP MeshWorks:** Learn to effectively modify geometries within DEP MeshWorks using CAD, FE or an hybrid approach, leveraging prior experience for quick adaptation to the new platform.

BAS-04Q Proficient Transition to DEP MeshWorks: Accelerated QUAD Meshing

Course detailed content

1. Accelerated Software Introduction

- ✓ Overview of DEP MeshWorks
- ✓ Intuitive Interface overview
- ✓ Hands-on Quick Start

2. Essential Mesh Techniques

- ✓ Essential CAD Tools
- ✓ Key meshing engines & Algorithms
- ✓ Mesh/FE Modifications
- ✓ Rapid Creation and Management of Templates
- ✓ Key Tools for Quality Checking & Visualization

3. Advanced QUAD Meshing

- ✓ Condensed QUAD Meshing Workflow
- ✓ Interactive remeshing

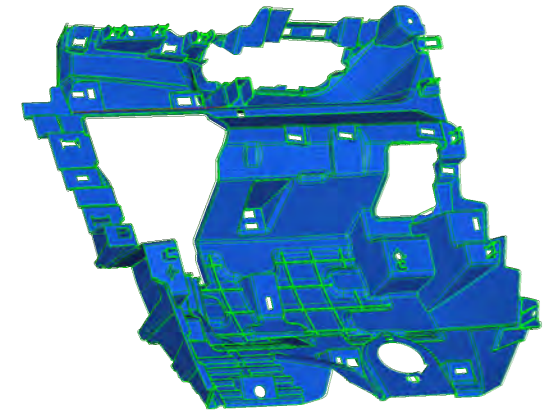
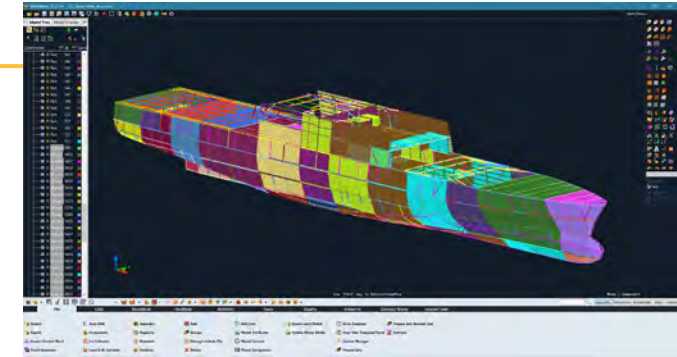
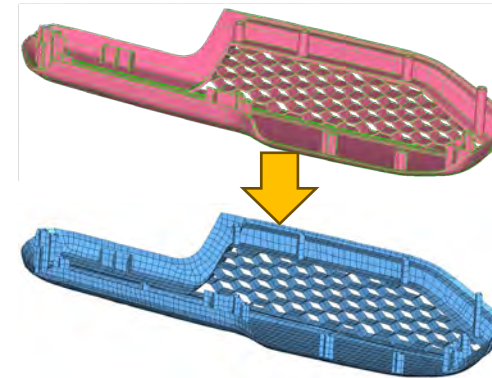
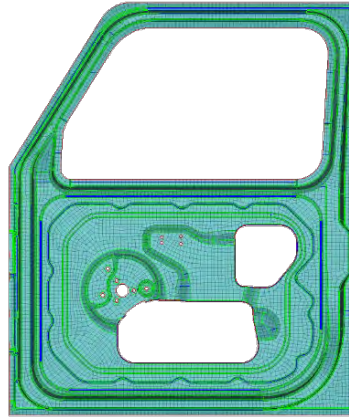

The key concepts of the training are illustrated with practical exercises.

- Fast-track your QUAD meshing expertise in DEP MeshWorks with our 'Proficient Transition to DEP MeshWorks: Accelerated QUAD Meshing' course. Tailored for experienced HyperMesh users, this intensive one-day course distills the essentials of QUAD meshing, combining a focused overview of DEP MeshWorks with practical, hands-on experience.
- Streamlined Learning: Dive into the core aspects of CAD cleaning, meshing and quality, specifically streamlined for those already familiar with meshing concepts.
- Advanced QUAD Meshing Skills: The course culminates with a condensed QUAD Meshing workflow, providing insights tailored for quick mastery.
- Designed specifically for professionals transitioning from HyperMesh, this course offers an accelerated pathway to mastering QUAD meshing in DEP MeshWorks, ensuring precision and efficiency in your meshing workflow.

BAS-04H Proficient Transition to DEP MeshWorks: Accelerated HEXA Meshing

Course overview

1. Accelerated Software Introduction
2. Essential Mesh Techniques
3. Advanced HEXA Meshing Techniques

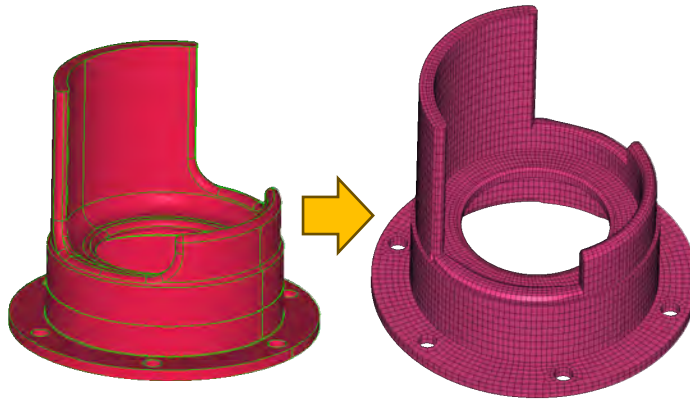
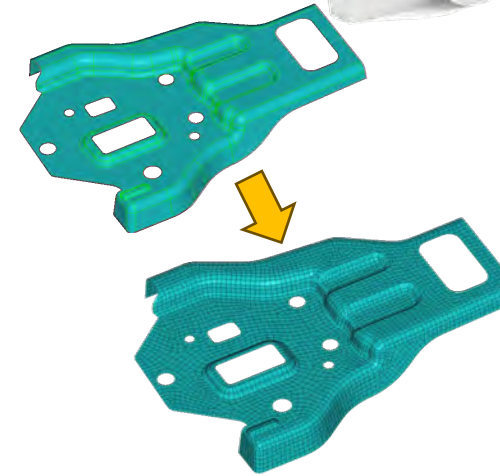
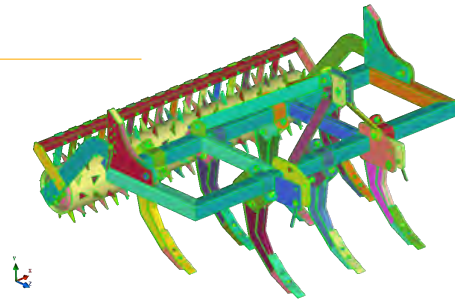

MAIN OBJECTIVE

- ✓ Equip trainees with the skills to seamlessly transition their meshing expertise to DEP MeshWorks, emphasizing a swift mastery of HEXA meshing capabilities.

PEDAGOGICAL OBJECTIVES

- ✓ **Seamless Transition to DEP MeshWorks:** Acquire the ability to efficiently transition existing meshing skills to DEP MeshWorks, with a focus on understanding its unique interface and functionalities.
- ✓ **Advanced Meshing Techniques Adaptation:** Master the adaptation of advanced surface and HEXA meshing techniques to DEP MeshWorks' environment, ensuring a smooth transfer of expertise.
- ✓ **Optimized Geometry Handling in DEP MeshWorks:** Learn to effectively modify geometries within DEP MeshWorks using CAD, FE or an hybrid approach, leveraging prior experience for quick adaptation to the new platform.



TARGETED AUDIENCE

- CAD / CAE engineers wishing to:
- learn how to do HEXA meshing using DEP MeshWorks



PREREQUISITE

Operational proficiency in CAD cleaning and meshing with HyperMesh experience.



DURATION

2 days (4 x 3.5 hours)



TRAINERS



BAS-04Q Proficient Transition to DEP MeshWorks: Accelerated HEXA Meshing

Course detailed content

1. Accelerated Software Introduction

- ✓ Overview of DEP MeshWorks
- ✓ Intuitive Interface overview
- ✓ Hands-on Quick Start

2. Essential Mesh Techniques

- ✓ Essential CAD Tools
- ✓ Key meshing engines & Algorithms
- ✓ Mesh/FE Modifications
- ✓ Key Tools for Quality Checking & Visualization

3. Advanced HEXA Meshing Techniques

- ✓ HEXA meshing strategies
- ✓ Extruded 3D Mesh Generation Tools
- ✓ Semi-automated HEXA Meshing Workflow
- ✓ Automated Tools for Update
- ✓ Interactive Modification & Useful Tips

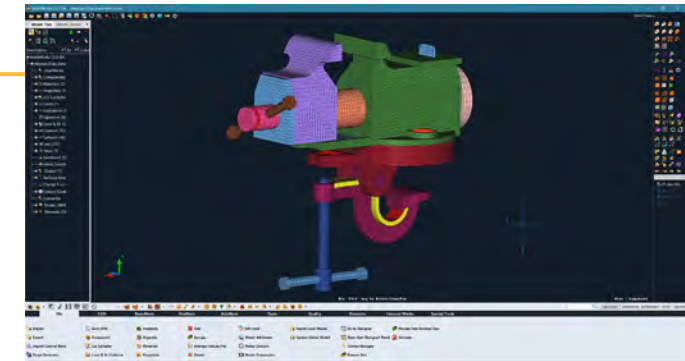
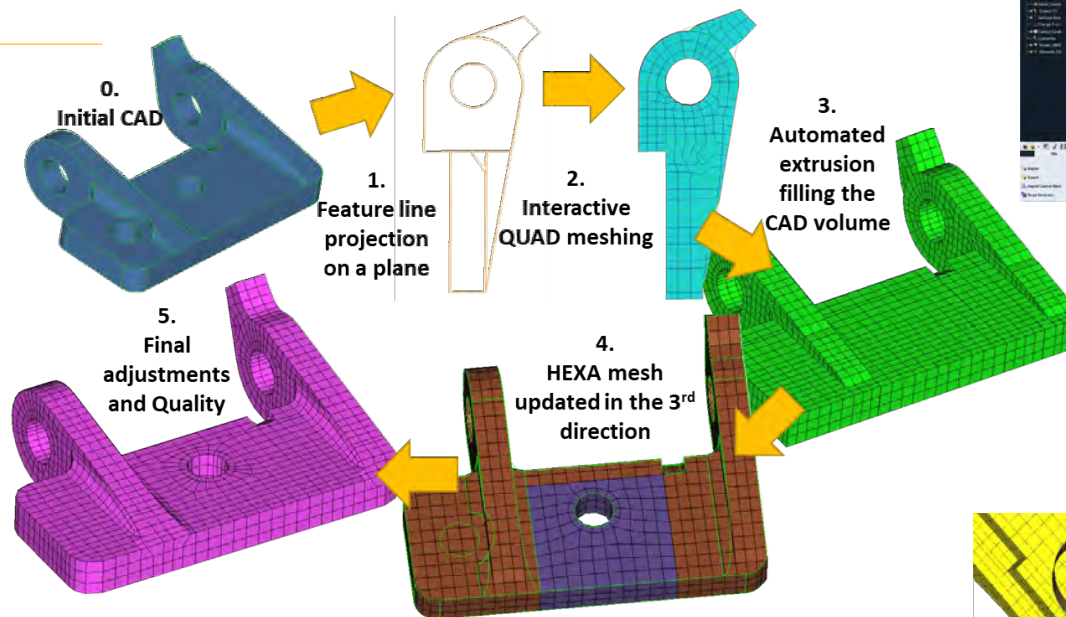

The key concepts of the training are illustrated with practical exercises.

- Fast-track your HEXA meshing expertise in DEP MeshWorks with our 'Proficient Transition to DEP MeshWorks: Accelerated HEXA Meshing' course. Tailored for experienced HyperMesh users, this intensive one-day course distills the essentials of HEXA meshing, combining a focused overview of DEP MeshWorks with practical, hands-on experience.
- Streamlined Learning: Dive into the core aspects of CAD cleaning, meshing and quality, specifically streamlined for those already familiar with meshing concepts.
- Advanced HEXA Meshing Skills: The course culminates with an advanced HEXA Meshing workflow, providing step-by-step procedure and insights tailored for quick mastery of the innovative approach given by DEP MeshWorks.
- Designed specifically for professionals transitioning from HyperMesh, this course offers an accelerated pathway to mastering HEXA meshing in DEP MeshWorks, ensuring precision and efficiency in your meshing workflow.

BAS-04T Proficient Transition to DEP MeshWorks: Accelerated TETRA Meshing



Course overview

1. Accelerated Software Introduction
2. Essential Mesh Techniques
3. Advanced TETRA Meshing

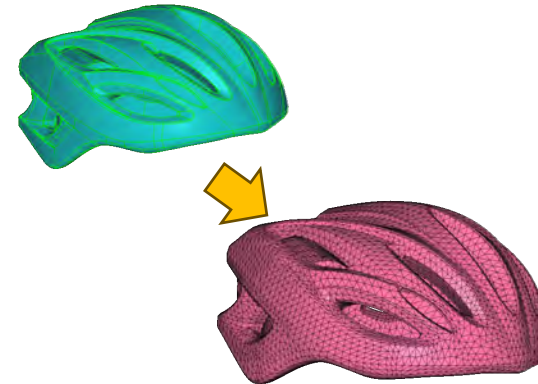
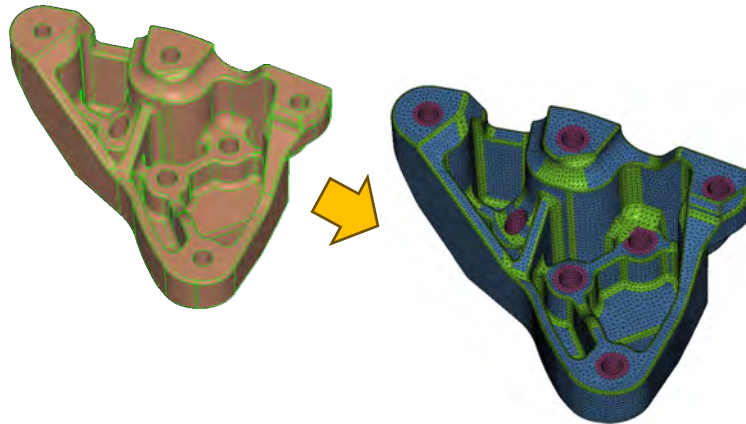
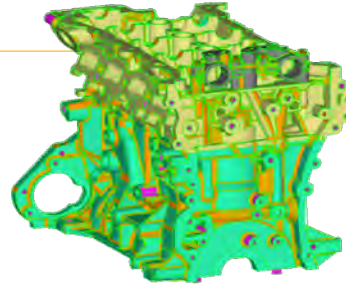

MAIN OBJECTIVE

- ✓ Equip trainees with the skills to seamlessly transition their meshing expertise to DEP MeshWorks, emphasizing a swift mastery of TETRA meshing capabilities.

PEDAGOGICAL OBJECTIVES

- ✓ **Seamless Transition to DEP MeshWorks:** Acquire the ability to efficiently transition existing meshing skills to DEP MeshWorks, with a focus on understanding its unique interface and functionalities.
- ✓ **Advanced Meshing Techniques Adaptation:** Master the adaptation of advanced surface and TETRA meshing techniques to DEP MeshWorks' environment, ensuring a smooth transfer of expertise.
- ✓ **Optimized Geometry Handling in DEP MeshWorks:** Learn to effectively modify geometries within DEP MeshWorks using CAD, FE or an hybrid approach, leveraging prior experience for quick adaptation to the new platform.



TARGETED AUDIENCE

- CAD / CAE engineers wishing to:
- learn how to do TETRA meshing using DEP MeshWorks



PREREQUISITE

Operational proficiency in CAD cleaning and meshing with HyperMesh experience.



DURATION

1 day (2 x 3.5 hours)



TRAINERS



BAS-04T Proficient Transition to DEP MeshWorks: Accelerated TETRA Meshing

Course detailed content

1. Accelerated Software Introduction

- ✓ Overview of DEP MeshWorks
- ✓ Intuitive Interface overview
- ✓ Hands-on Quick Start

2. Essential Mesh Techniques

- ✓ Essential CAD Tools
- ✓ Key meshing engines & Algorithms
- ✓ Mesh/FE Modifications
- ✓ Rapid Creation and Management of Templates
- ✓ Key Tools for Quality Checking & Visualization

3. Advanced TETRA Meshing

- ✓ Condensed TETRA Meshing Workflow
- ✓ Interactive remeshing

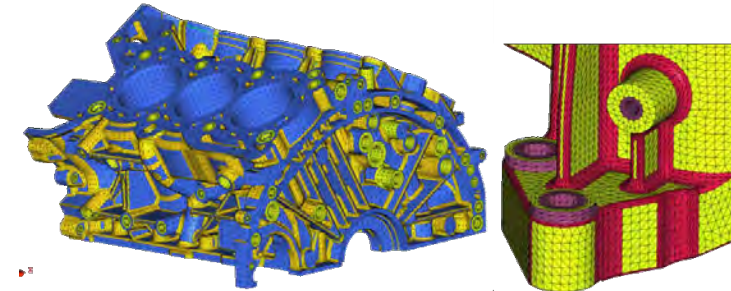
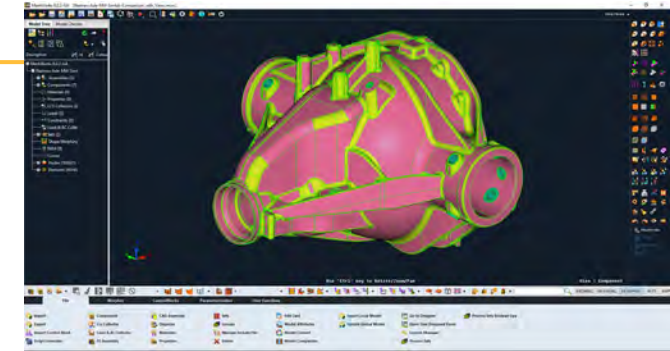
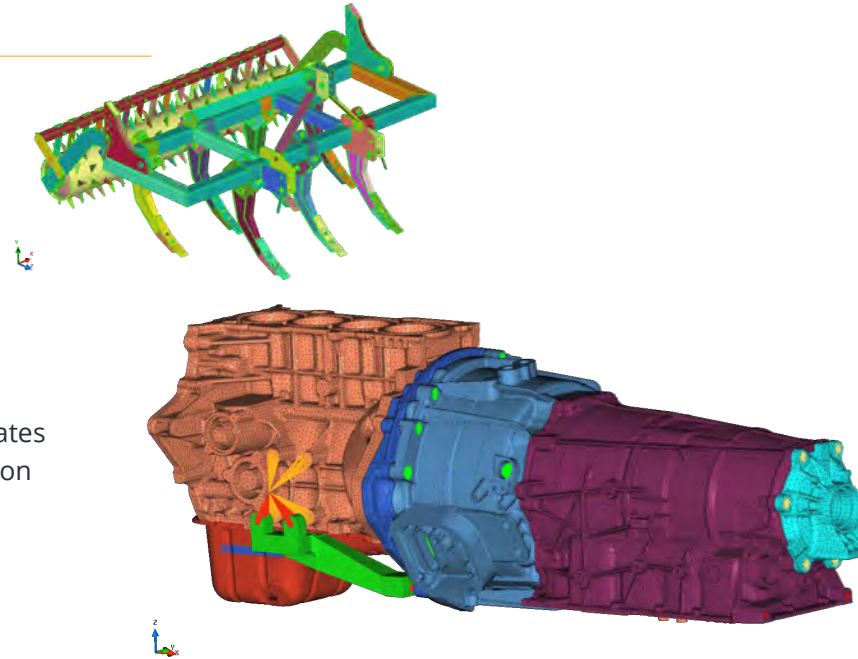

The key concepts of the training are illustrated with practical exercises.

- Fast-track your TETRA meshing expertise in DEP MeshWorks with our 'Proficient Transition to DEP MeshWorks: Accelerated TETRA Meshing' course. Tailored for experienced HyperMesh users, this intensive one-day course distills the essentials of TETRA meshing, combining a focused overview of DEP MeshWorks with practical, hands-on experience.
- Streamlined Learning: Dive into the core aspects of CAD cleaning, meshing and quality, specifically streamlined for those already familiar with meshing concepts.
- Advanced TETRA Meshing Skills: The course culminates with a condensed TETRA Meshing workflow, providing insights tailored for quick mastery.
- Designed specifically for professionals transitioning from HyperMesh, this course offers an accelerated pathway to mastering TETRA meshing in DEP MeshWorks, ensuring precision and efficiency in your meshing workflow.

COMP-01 PRE-Processing: Multi-Solver Integration and Efficient Assembly



Course overview

1. Introduction to Multi-Solver Preprocessing
2. Model Assembly and Conversion Techniques
3. Hands-On Training in Model Setup
4. Advanced Assembly Functions

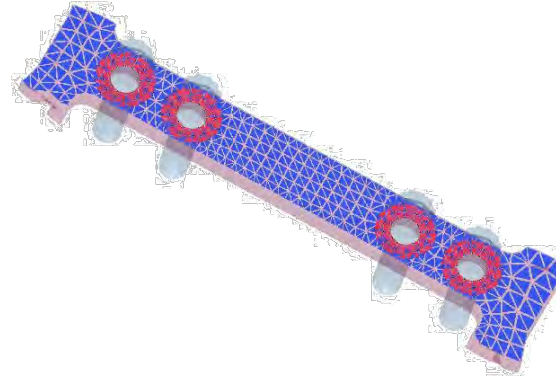

LS-DYNA

Component	Sets	Assign	Joints	Define Vector	Initials	Manage Include File	Mass Calculation
Assembly	Coord Systems	Loads	Contacts	Vector Collector	Rigid Wall	Element Config Edit	Hourglass
Lcs Collector	Materials	Boundaries	Curves	Define Transform	Control Cards	Edit Card	Airbag
Load & Bc Collector	Sections	Constraints	Tables	Define Box	DataBase	Renumber	Composite Ply

ABAQUS

Component	Sets	Assign	Contacts	Loads	Output	Element Config Edit
Assembly	Coord Systems	Contact Surface	Connectors	SubModel	Step	Edit Card
Lcs Collector	Materials	Surface Interaction	Boundaries	Initial Conditions	Manage Include File	Renumber
Load & Bc Collector	Properties	Change Friction	Equation	Control Cards	Mass Calculation	

NASTRAN

Component	Sets	Assign	Constraints	Manage Include File	Mass Calculation	Design Variable
Assembly	Coord Systems	Contact Surface	Curves	Element Config Edit	Material Orientation	Shape Domain
Lcs Collector	Materials	Contacts	NSM	Edit Card		
Load & Bc Collector	Properties	Loads	Sub Case Manager	Renumber	Shape Morphing Set	

MAIN OBJECTIVE

- ✓ To empower participants with comprehensive capabilities in pre-processing, focusing on model assembly and model setup

PEDAGOGICAL OBJECTIVES

- ✓ **Multi-Solver Proficiency:** Develop the ability to adapt pre-processing for various solvers.
- ✓ **Model Assembly Expertise:** Master advanced model assembly techniques, increasing efficiency in developing complex models.
- ✓ **Model Conversion Acumen:** Learn the nuances of model conversion, facilitating flexibility in working across different solvers.
- ✓ **Efficient Model Setup:** Acquire skills for setting up models in MeshWorks, streamlining the process.



TARGETED AUDIENCE

CAE engineers looking to enhance their skills in an advanced, multi-solver environment.



PREREQUISITE

Familiarity with basic CAE concepts and Operational knowledge of the required solvers



DURATION

0.5 day



TRAINERS



- ✓ **Practical Application and Adaptation:** Apply these skills in a hands-on setting, with a focus on adapting MeshWorks' advanced capabilities to outperform traditional preprocessing methods.

COMP-01 PRE-Processing: Multi-Solver Integration and Efficient Assembly

Course detailed content

1. Introduction to Multi-Solver Preprocessing

- ✓ Navigating through NASTRAN, ABAQUS, and LS-DYNA environments in MeshWorks.
- ✓ Tailoring preprocessing approaches to suit different solver requirements.

2. Model Assembly and Conversion Techniques

- ✓ Advanced strategies for assembling complex models in MeshWorks, applicable to various industries.
- ✓ Model conversion feature: seamlessly transitioning models between different solvers.

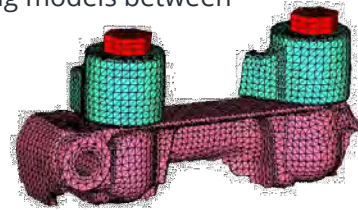

The key concepts of the training are illustrated with practical exercises.

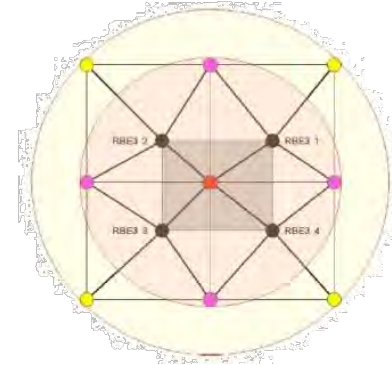

3. Hands-On Training in Model Setup

- ✓ Practical workshop on efficient model setup in MeshWorks, suitable for both beginners and experienced users.
- ✓ Emphasis on time-saving and accuracy-enhancing techniques in model preparation.

4. Advanced Assembly Functions

- ✓ Exploring MeshWorks' advanced model assembly functions: seam and spot welds, bolt connections, contacts creation, and more.
- ✓ Detailed walkthrough of automated and semi-automated functions for intricate component connections.

- "Pre Processing: Multi-Solver Integration and Efficient Assembly" offers an innovative approach to CAE preprocessing, blending foundational learning with advanced techniques. This course is designed to revolutionize model assembly and setup in multi-solver environments, providing an edge to both new and seasoned professionals in the CAE field.

COMP-02 POST-Processing Proficiency: Enhancing Design Analysis



Course overview

1. Introduction to Advanced Post-Processing
2. Result Analysis and Visualization Techniques
3. Innovative Post-Processing Features
4. Design Improvement and Iteration Tools

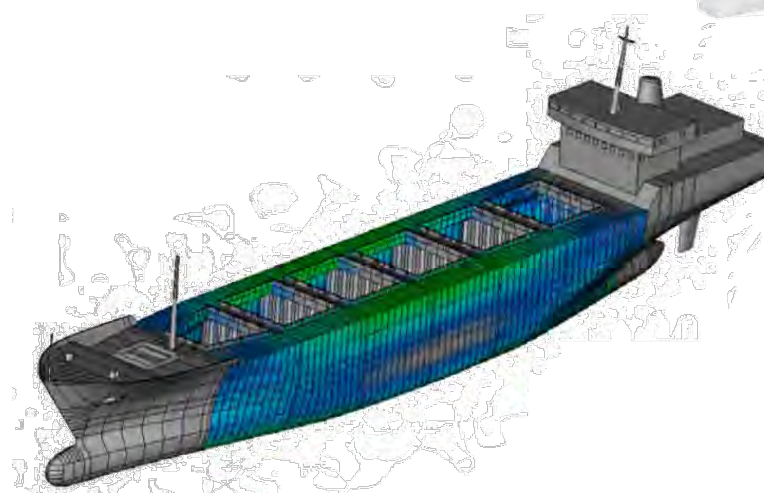
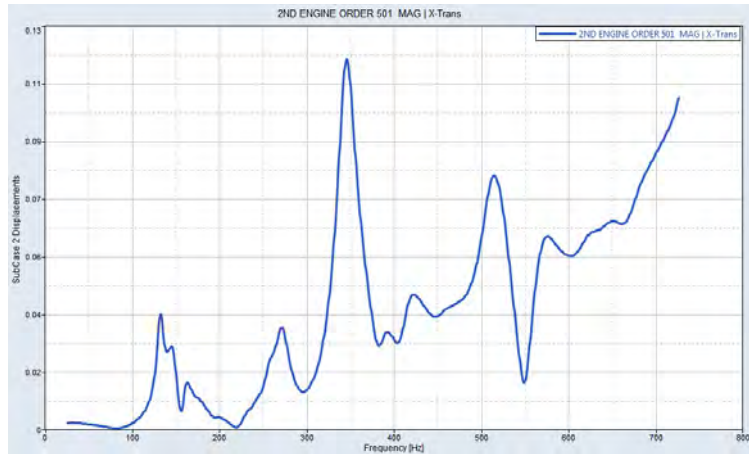

TARGETED AUDIENCE

CAE engineers seeking to enhance their analytical capabilities in post-processing, particularly those requiring detailed simulation result analysis.



PREREQUISITE

Operation knowledge of DEP MeshWorks PRE-Processing (COMP-01 required) and Operational knowledge of the required solvers



DURATION

0.5 day



TRAINERS



MAIN OBJECTIVE

- ✓ To equip participants with post-processing skills, focusing on advanced analysis, visualization techniques, and design improvement strategies.

PEDAGOGICAL OBJECTIVES

- ✓ **Comprehensive Analysis Skills:** Develop the ability to analyze and interpret complex simulation results effectively.
- ✓ **Visualization Mastery:** Master advanced visualization techniques for a clear understanding of simulation outcomes.
- ✓ **Automated Feature Utilization:** Learn to utilize MeshWorks' automated post-processing features for efficient result analysis.
- ✓ **Design Improvement Insights:** Gain insights into how post-processing can inform and improve design iterations.
- ✓ **Practical Application:** Apply these skills in practical scenarios, transitioning from post-processing results to direct design impact studies.

COMP-02 POST-Processing Proficiency: Enhancing Design Analysis

Course detailed content

1. Introduction to Advanced Post-Processing

- ✓ Exploring MeshWorks' multi-disciplinary post-processor for simulation result analysis.
- ✓ Understanding the functionalities for reporting mechanical system performance.

2. Result Analysis and Visualization Techniques

- ✓ Learning to load, view, and interpret result files from various solvers.
- ✓ Utilizing colour contour plots, animations, deformed shape plots, and X-Y plots.

The key concepts of the training are illustrated with practical exercises.

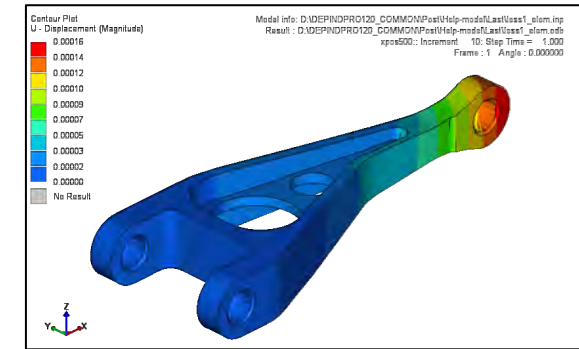
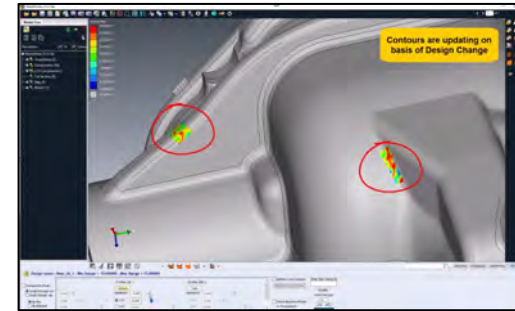

3. Innovative Post-Processing Features

- ✓ Automated extraction of peak stress values, vibration amplitudes, and hot spot results.
- ✓ Hands-on practice with advanced tools for comprehensive model studies.

4. Design Improvement and Iteration Tools

- ✓ Exploring automated post-processing features for component and full-vehicle models.
- ✓ Enhancing design iterations through hot spot detection and unionization with host models.

- "Post-Processing Proficiency: Enhancing Design Analysis" is an essential course for professionals who want to leverage the full potential of MeshWorks in post-processing. This course not only teaches advanced analysis techniques but also demonstrates how to utilize these insights for real-world design improvements, thereby streamlining the conventional design cycle.

COMP-03 Accelerating CAE Workflow: Morphing Techniques



Course overview

1. Introduction to Morphing in CAE
2. Core Morphing Techniques
3. Advanced Morphing Algorithms
4. Parameterization and Innovative design
5. Expanding Morphing Capabilities

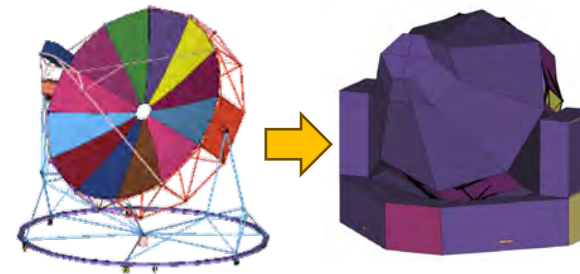
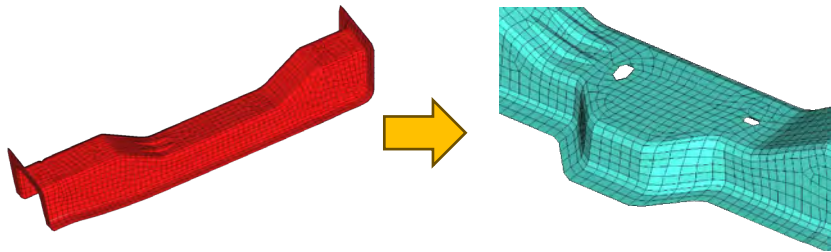
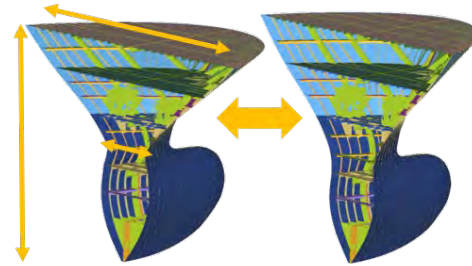
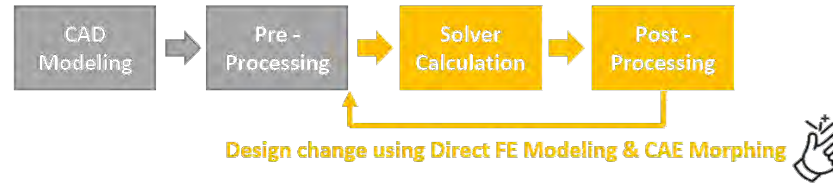

TARGETED AUDIENCE

CAD/CAE engineers wishing to develop morphing and parameterization strategies and master the associated tools to accelerate their CAE workflow



PREREQUISITE

Operational knowledge of DEP MeshWorks (BAS-0X required)



DURATION

1 day (2 x 3.5 hours)



TRAINERS



MAIN OBJECTIVE

- ✓ Deep dive into DEP MeshWorks' morphing and parameterization, focusing on practical strategies and the utilization of tools for CAE workflow acceleration.

PEDAGOGICAL OBJECTIVES

- ✓ **Morphing Fundamentals:** Understand the core principles of morphing and their practical applications in CAE.
- ✓ **Technique Proficiency:** Master various DEP MeshWorks-specific morphing techniques, enhancing skills for complex engineering tasks.
- ✓ **Outcome-Focused Approach:** Learn to leverage morphing capabilities to achieve desired results.
- ✓ **Parameterization and DOE Skills:** Develop the ability to create effective parameterizations for efficient Design of Experiments (DOE) setups.
- ✓ **Applied Methodologies:** Implement diverse morphing methodologies, utilizing case studies to broaden real-world application skills

COMP-03 Accelerating CAE Workflow: Morphing Techniques

Course detailed content

1. Introduction to Morphing in CAE

- ✓ Theory
- ✓ Practical Use
- ✓ Morphing Explained

2. Core Morphing Techniques

- ✓ 'Freeform' Method
- ✓ 'Control Block' (CB) Method
 - Creation of CB
 - Modifying CB for Desired Outcomes
- ✓ Morphing on the Fly

3. Advanced Morphing Algorithms

- ✓ 'Field Based' Approach
- ✓ 'Higher Order' Approach

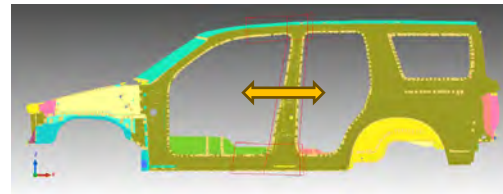
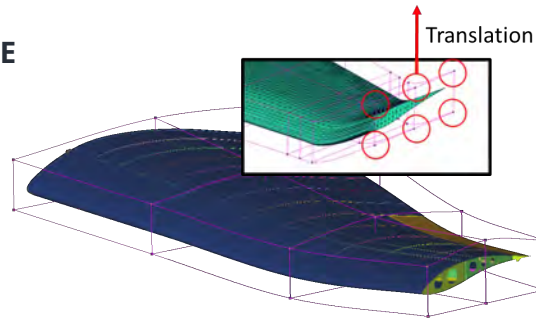

4. Parameterization and Innovative design

- ✓ Design Exploration set up
- ✓ Design & DOE Generation

5. Expanding Morphing Capabilities

- ✓ Geometric Transformations
- ✓ Projection & Mapping Transformations
- ✓ General Transform Parameter
- ✓ Macro Parameter: AutoQuality Post-Morphing

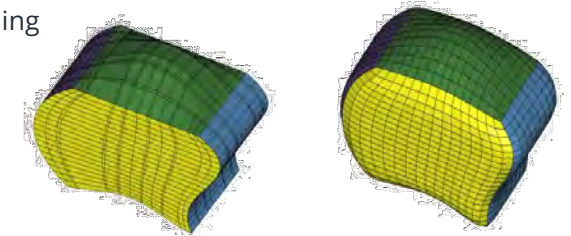
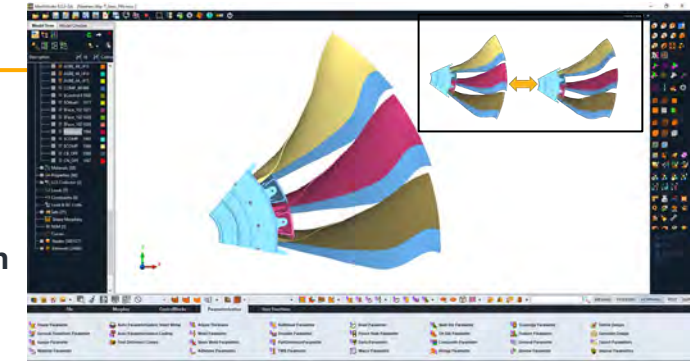

The key concepts of the training are illustrated with practical exercises.

- Embark on a journey to master the art of accelerating your CAE workflow with 'Accelerating CAE Workflow: Morphing Techniques & Applications'.
- This course delves deep into both the theoretical foundations and practical applications of morphing within CAE. From the essential 'Freeform' and 'Control Block' methods to sophisticated algorithms, you'll uncover the secrets to rapid and efficient design and analysis.
- Tailored for engineers seeking to elevate their proficiency in CAE design and optimization, this course offers a wealth of knowledge in parameterization, design generation, and advanced modeling techniques. You'll learn how to effectively apply various geometric transformations, projection, and mapping to streamline your engineering processes.
- Gain the skills to not only transform and refine designs but also to dramatically enhance the efficiency of your CAE workflow. This course is an invaluable resource for those looking to blend precision with creativity in their engineering solutions.

ADV-01 Transformative CAD Morphing Workflow



Course overview

1. Introduction to CAD Morphing Technologies
2. Core CAD Morphing Techniques
3. Automated CAD Update with 'Impose Deformation'

Model	Initial	Final
CAD	✗	✗
Mesh	✗	✗

Optimized FE model obtention

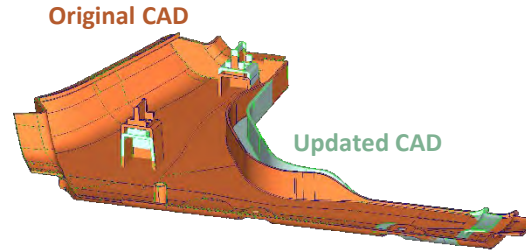
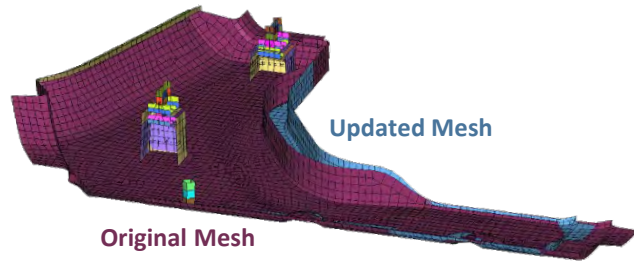

MAIN OBJECTIVE

- ✓ To provide an in-depth understanding of CAD morphing techniques, focusing on the innovative use of DEP MeshWorks' 'Impose Deformation' feature.

PEDAGOGICAL OBJECTIVES

- ✓ **Understanding CAD Morphing:** Grasp the fundamental concepts of CAD morphing and its significance in modern design workflows.
- ✓ **Morphing Techniques:** Discover Freeform and Control Block morphing methods within the CAD context.
- ✓ **Practical Application:** Gain hands-on experience in applying these morphing techniques using DEP MeshWorks, reinforcing theoretical knowledge with practical skills.
- ✓ **Automated CAD Adaptation:** Learn to implement the 'Impose Deformation' feature for dynamic and automatic updates to CAD models based on mesh changes.



TARGETED AUDIENCE

CAD / CAE engineers seeking to expand their toolkit with advanced morphing capabilities and streamline their design workflow



PREREQUISITE

Operational knowledge of DEP MeshWorks and its CAE Morphing capabilities (COMP-03 required)



DURATION

0.5 day



TRAINERS



ADV-01 Transformative CAD Morphing Workflow

Course detailed content

1. Introduction to CAD Morphing Technologies

- ✓ Context of Patented Technology
- ✓ Theoretical Background and Application Scenarios
- ✓ Explanation of CAD Morphing Concepts

2. Core CAD Morphing Techniques

- ✓ Freeform Morphing Method
- ✓ Control Block Morphing Technique
- ✓ Practical Hands-On with DEP MeshWorks

3. Automated CAD Update with 'Impose Deformation'

- ✓ Implementing Automatic CAD Updates
- ✓ Aligning Mesh Modifications with CAD Models

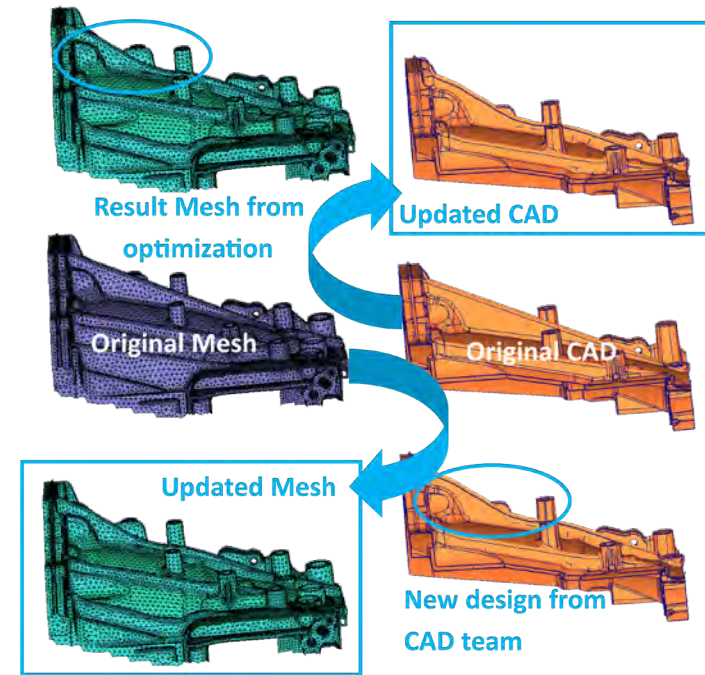

The key concepts of the training are illustrated with practical exercises.

- This course offers a transformative journey into CAD morphing, blending patented technologies with practical methodologies. Participants will explore techniques like Freeform and Control Block morphing, gaining hands-on experience with DEP MeshWorks. A special focus on the 'Impose Deformation' feature demonstrates how CAD models can be automatically updated in response to mesh changes, marking a significant advancement in CAD design workflows.

ADV-02 Efficiency through Process Automation: Streamlining CAE workflows



Course overview

1. Introduction to Process Automation in CAE
2. Developing Custom GUIs and Specialist Menus
3. Command Recording and Macro Integration
4. Python Integration and Scripting
5. Debugging Strategies and Advanced Options
6. Customized Live Workshop

3 easy steps to create your own dedicated workflow tool

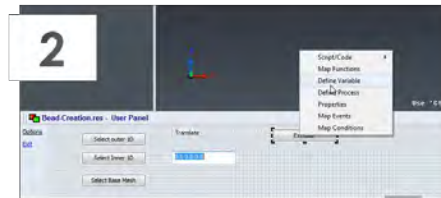

Create your GUI by click & drop



Plumb the GUI with recorded process chart



Record your workflow

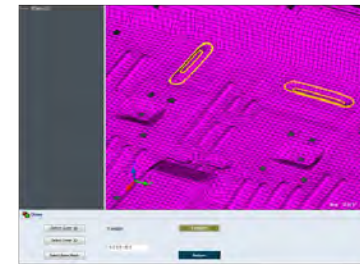

Publish and use the tool



TARGETED AUDIENCE

CAD / CAE engineers and developers who want to master the process automation capabilities of DEP MeshWorks



PREREQUISITE

Operational knowledge of DEP MeshWorks (BAS-0X required)



DURATION

3 days, including a tailored live workshop on the final day for practical application and customization based on customer needs.



TRAINERS



MAIN OBJECTIVE

- ✓ Equip participants with comprehensive skills and knowledge to create, modify, and optimize automated specialist processes, known as Process Automation (PA) of DEP MeshWorks

PEDAGOGICAL OBJECTIVES

- ✓ **Foundational Understanding:** Grasp the fundamental principles and capabilities of the "Process Automation" tool in DEP MeshWorks.
- ✓ **GUI and Menu Creation:** Learn to design personalized user interfaces and specialist menus tailored to specific workflow requirements.
- ✓ **Command Recording Mastery:** Develop the ability to record and utilize commands in DEP MeshWorks for creating and refining automated processes.
- ✓ **Macro-Interface Linking:** Acquire skills to establish connections between user interfaces and recorded macro commands.
- ✓ **Python Integration:** Understand how to incorporate Python scripts and executables into DEP MeshWorks for advanced process automation.
- ✓ **Debugging Proficiency:** Gain insights into effective debugging techniques for maintaining and troubleshooting process automation workflows.

ADV-02 Efficiency through Process Automation: Streamlining CAE workflows

Course detailed content

1. Introduction to Process Automation in CAE

- ✓ Understanding General Principles
- ✓ Exploring the Scope and Impact of Automation in CAE Workflows

2. Developing Custom GUIs and Specialist Menus

- ✓ Techniques for Creating User Interfaces
- ✓ Building Specialized Menus within DEP MeshWorks

3. Command Recording and Macro Integration

- ✓ Mastering Command Recording for Process Automation
- ✓ Linking Interfaces with Recorded Macros

4. Python Integration and Scripting

- ✓ Utilizing Python Routines for Advanced Automation
- ✓ Scripting and Programming within the DEP MeshWorks Environment



5. Debugging Strategies and Advanced Options

- ✓ Tips and Techniques for Efficient Debugging
- ✓ Exploring Advanced Features for Process Customization

6. Customized Live Workshop

- ✓ Hands-On Workshop Tailored to the Customer's Specific Needs



**Process
Automation**

The key concepts of the training are illustrated with practical exercises.

- This course is designed to empower professionals to enhance efficiency in CAE workflows through advanced process automation. Participants will gain expertise in creating custom GUIs, integrating command macros, utilizing Python scripts, and debugging within DEP MeshWorks. The course culminates in a customized live workshop, offering practical, hands-on experience tailored to real-world applications.

ADV-03 Bridging with LS-OPT Software for Optimized Design



Course overview

1. Preparation for Optimization
2. Design of Experiments (DOE) Generation
3. Integration and Optimization Process
4. Final Adjustments and Debugging

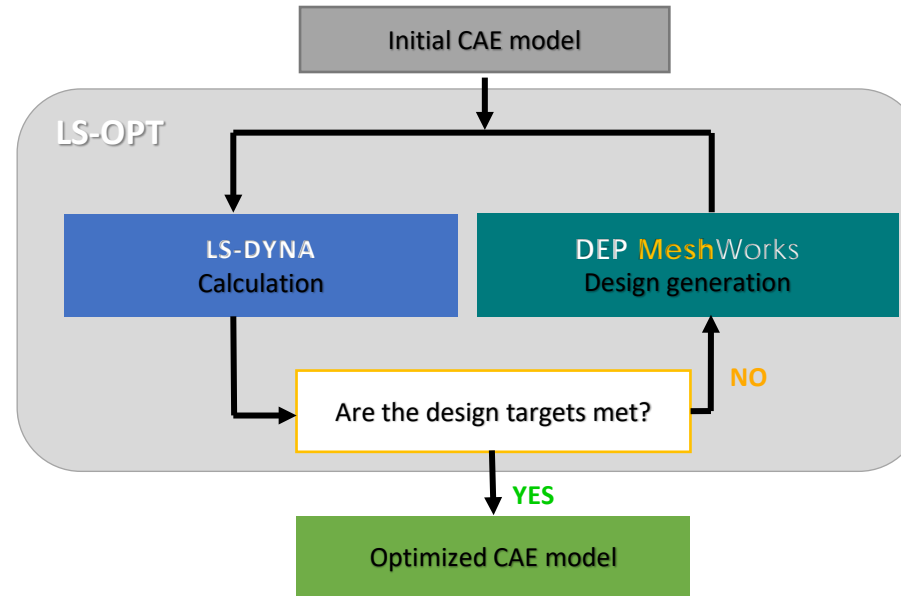

MAIN OBJECTIVE

- ✓ Equip participants with the knowledge and skills to effectively couple DEP MeshWorks, LS-DYNA, and LS-OPT for design optimization.

PEDAGOGICAL OBJECTIVES

- ✓ **Optimization-Ready LS-DYNA Models:** Gain expertise in preparing LS-DYNA models for the optimization process.
- ✓ **Mastery of LS-OPT Process:** Understand the complete optimization process utilizing LS-OPT, including system parameterization and DOE creation.
- ✓ **Effective DOE Creation and Modification:** Learn to create and modify DOE setups directly in DEP MeshWorks, with and without interfaces, including the import of parameter data.
- ✓ **DEP MeshWorks and LS-OPT Coupling:** Develop the capability to generate coupling files that link DEP MeshWorks with LS-OPT for seamless optimization workflows.



TARGETED AUDIENCE

CAD / CAE engineers wishing to develop parametrical optimization strategies improving their product development process



PREREQUISITE

Operational knowledge of DEP MeshWorks (BAS-0X required), its parameterization capabilities (COMP-03 required) and LS-OPT



DURATION

0.5 day



TRAINERS



ADV-03 Bridging with LS-OPT Software for Optimized Design

Course detailed content

1. Preparation for Optimization

- ✓ Preparing an LS-DYNA Model for Optimization
- ✓ Setting Up the DEP MeshWorks File

2. Design of Experiments (DOE) Generation

- ✓ Strategies for Generating Effective DOE in DEP MeshWorks
- ✓ Creation and Adjustment of LS-OPT Files

3. Integration and Optimization Process

- ✓ Understanding the Optimization Process with LS-OPT
- ✓ Deep Dive into Model Parameterization Systems

4. Final Adjustments and Debugging

- ✓ Implementing Final Adjustments for Optimal Design
- ✓ Practical Debugging Tips for Optimization

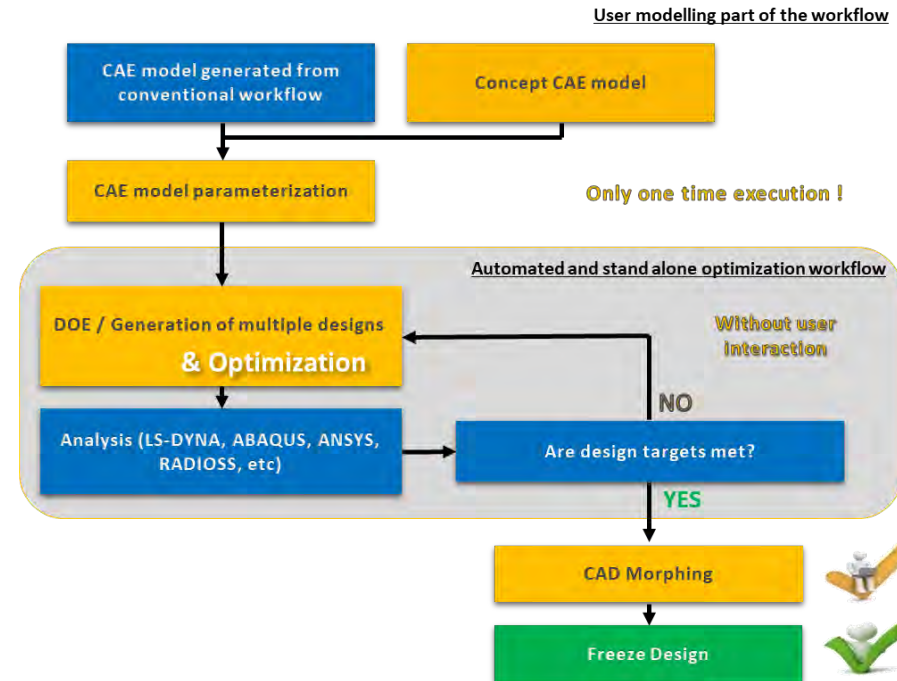

The key concepts of the training are illustrated with practical exercises.

- This course offers a concise yet comprehensive journey through the optimization process, specifically focusing on the integration of DEP MeshWorks, LS-DYNA, and LS-OPT.
- Participants will learn to transform an LS-DYNA model based on optimization specifications to achieve the optimal design, gaining insights into model preparation, DOE generation, and system parameterization.

SPE-01 ConceptWorks – Revolutionizing Sheet Metal Design



Course overview

1. Member and Hollow Body Creation
2. Joint Design and Innovation
3. Inner Structural Components
4. Concept Enhancement Techniques

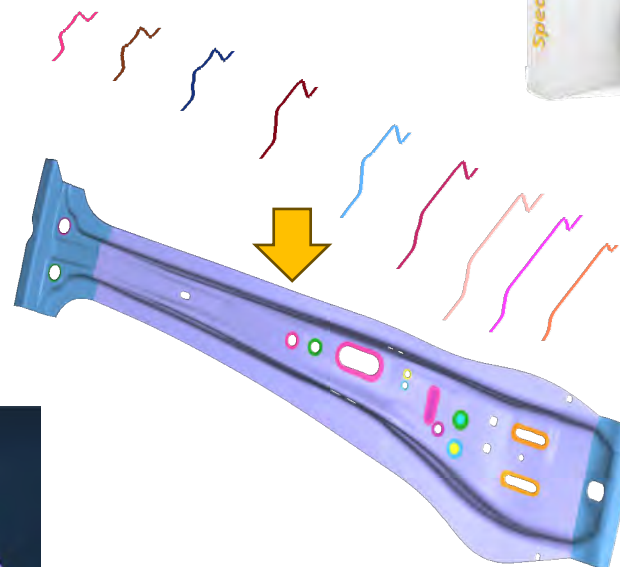
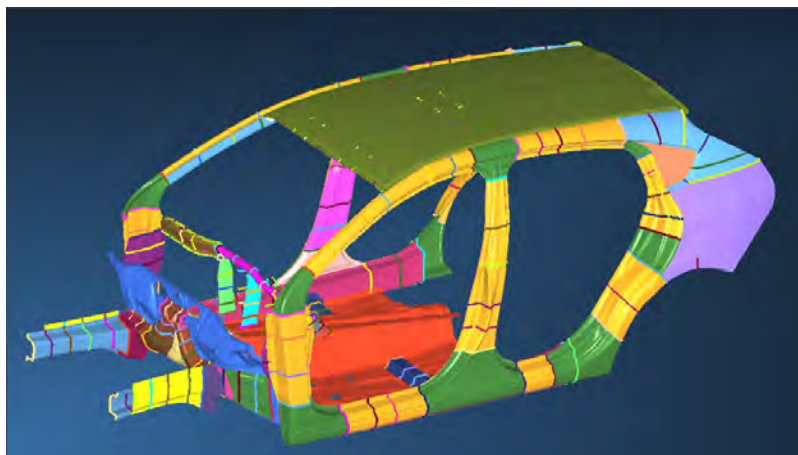

TARGETED AUDIENCE

CAE engineers in the automotive sector (crash, NVH, stamping) wishing to significantly accelerate their design cycles.



PREREQUISITE

Operational knowledge of DEP MeshWorks and its CAE Morphing capabilities (COMP-03 required)



DURATION

1 day



TRAINERS



MAIN OBJECTIVE

- ✓ To equip participants with the skills to proficiently creating and modifying structural components like hollow bodies and joints, directly at the FE level, with a focus on efficiency and innovation.

PEDAGOGICAL OBJECTIVES

- ✓ **Comprehension of ConceptWorks:** Grasp the philosophy and capabilities of ConceptWorks, including real-world application examples.
- ✓ **Member Creation Mastery:** Learn to create members using existing cross-section databases and sketch new sections for customized solutions.
- ✓ **Joint Design Skills:** Acquire the ability to design various joints, enhancing structural integrity and design versatility.
- ✓ **Assembly Optimization:** Master techniques to adjust and depenetrate mid-surfaces in assemblies for optimized design.
- ✓ **Rapid Structural Modifications:** Develop the skill to swiftly modify structural designs at a localized level, leveraging the module's advanced capabilities.

SPE-01 ConceptWorks – Revolutionizing Sheet Metal Design

Course detailed content

1. Member and Hollow Body Creation

- ✓ Constant cross-section along one section
- ✓ Constant cross-section from an existing one
- ✓ Variable cross-section using different trajectories
- ✓ Variable cross-section using multiple input sections
- ✓ Variable cross-section on reference plane
- ✓ Advanced method for complex floors

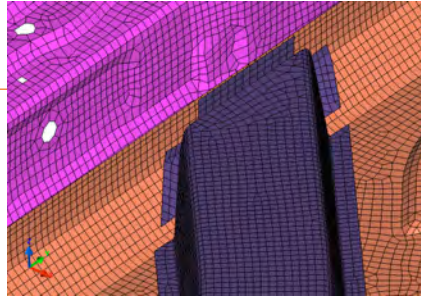

2. Joint Design and Innovation

- ✓ Extruded joint with automated flange projection
- ✓ External joint with automated flange projection
- ✓ External wall joint
- ✓ End Caps
- ✓ Auto joint

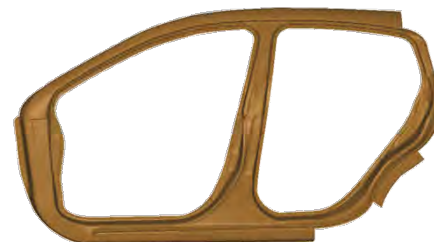
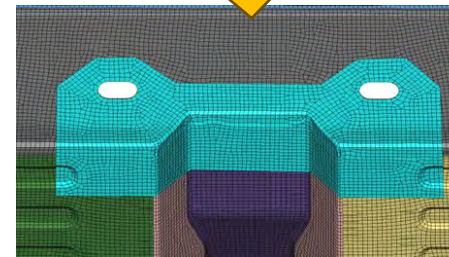
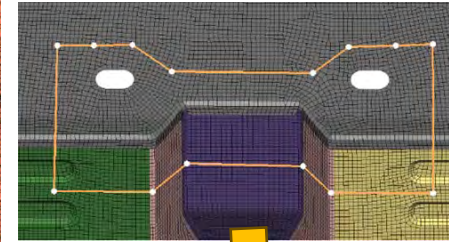
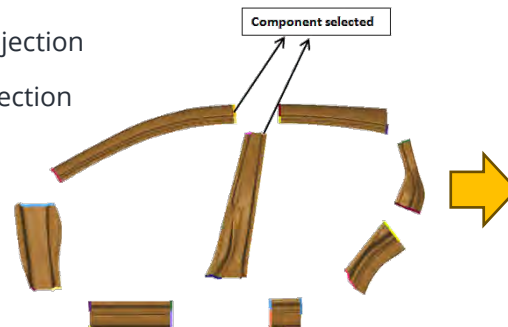

3. Inner Structural Components

- ✓ A-Pillar
- ✓ Roof rail
- ✓ Header / Roof bow
- ✓ Header / Bow joint
- ✓ B-Pillar

4. Concept Enhancement Techniques

- ✓ Holes
- ✓ Beads
- ✓ Bosses
- ✓ Structural stiffeners
- ✓ Patches
- ✓ Fillets
- ✓ Split
- ✓ Automatic flange adjustment
- ✓ Morphing

The key concepts of the training are illustrated with practical exercises.

- "ConceptWorks Mastery: Revolutionizing Sheet Metal Design" is an intensive, hands-on course designed to transform how automotive CAE engineers approach sheet metal design. Participants will gain invaluable insights and practical skills in creating, adjusting, and optimizing structural components, markedly accelerating design processes and enhancing product quality.

SPE-02 ConceptWorks Plastics – Automated Design Innovations



Course overview

1. Introduction to ConceptWorks for Plastics
2. Specialized Feature Creation
3. Advanced Rib Creation and Quality Management
4. Practical Application and Design Optimization

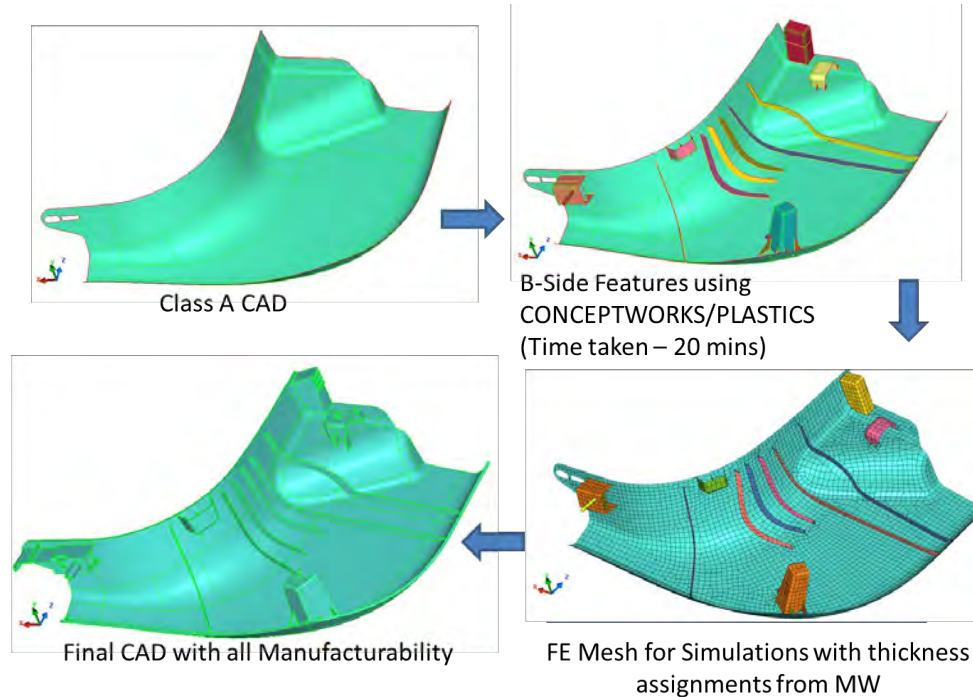

MAIN OBJECTIVE

- ✓ To provide participants with a thorough understanding and practical skills in using the ConceptWorks Plastics module for automated plastics design, enhancing efficiency and innovation in their projects.

PEDAGOGICAL OBJECTIVES

- ✓ **Automated Design Proficiency:** Develop expertise in the automated design capabilities of ConceptWorks for plastics.
- ✓ **Specialized Feature Creation:** Master the creation of specialized plastic features and their combinations.
- ✓ **Complex Rib Design:** Learn to design complex rib structures, including honeycomb patterns, with automated quality assurance.
- ✓ **Practical Design Application:** Apply these techniques in practical design scenarios, focusing on optimizing the design process for plastic components.
- ✓ **Innovation in Plastics Design:** Explore innovative approaches to plastics design, leveraging ConceptWorks' capabilities to push the boundaries of conventional design.



TARGETED AUDIENCE

Designers, engineers involved in plastics design and manufacturing, looking to harness automated design tools for enhanced efficiency and innovation.



PREREQUISITE

Operational knowledge of DEP MeshWorks with QUAD Meshing focus (BAS-01Q required)



DURATION

0.5 day



TRAINERS



SPE-02 ConceptWorks Plastics – Automated Design Innovations

Course detailed content

1. Introduction to ConceptWorks for Plastics

- ✓ Exploring the capabilities of the ConceptWorks Plastics module in creating specialist features efficiently.
- ✓ Understanding the automated design process at both CAD and FE levels.

2. Specialized Feature Creation

- ✓ Techniques for designing heat stakes, locators, clip sections, clip towers, locator pins, and dog house base features.
- ✓ Approaches to combine multiple features, such as 'Dog House - Heat Stake' and 'Dog House Locator'.

3. Advanced Rib Creation and Quality Management

- ✓ Methods for creating simple, complex, and honeycomb ribs.
- ✓ Ensuring high-quality insertions in complex areas through automated processes.

4. Practical Application and Design Optimization

- ✓ Hands-on training in using ConceptWorks Plastics module for real-world scenarios.
- ✓ Focusing on design efficiency and optimization for plastic components.

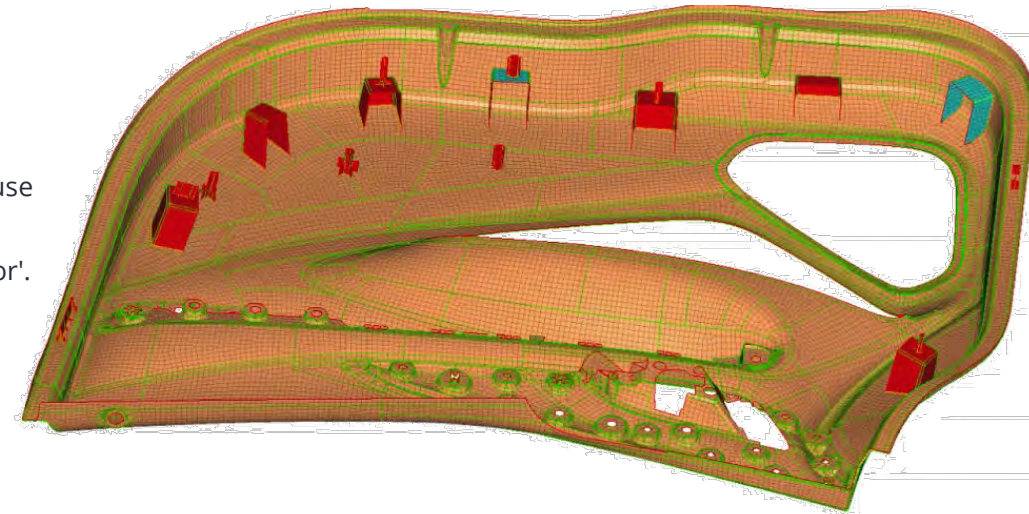

The key concepts of the training are illustrated with practical exercises.

- "ConceptWorks Plastics: Automated Design Innovations" is an advanced course tailored for professionals in the plastics industry. It equips participants with cutting-edge skills in automated plastics design, enabling them to create complex and innovative components with ease and precision using the ConceptWorks Plastics module.

SPE-03 Full Vehicle Morphing Mastery: Redefining Vehicle Design



Course overview

1. Foundational Training Phase: Mastering Vehicle Morphing Technologies
2. Supervision and Coaching Phase: Practical Application on a Pilot Project

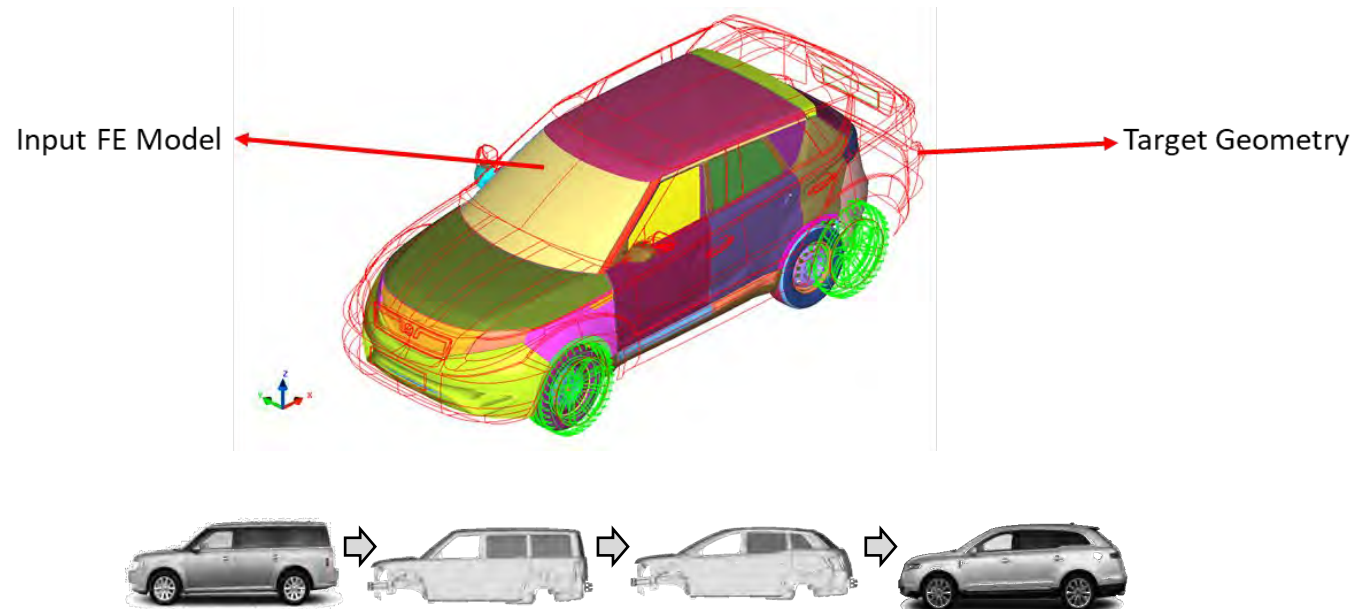

MAIN OBJECTIVE

- ✓ To empower participants to proficiently master the methodologies for updating the design of both EF and CAD vehicles through morphing, ultimately achieving a newly designed EF vehicle model.

PEDAGOGICAL OBJECTIVES

- ✓ **Advanced Morphing Techniques:** Develop an in-depth understanding of morphing, particularly for complex assemblies such as full vehicles.
- ✓ **Practical Morphing Application:** Learn to morph an existing vehicle into a new developmental model.
- ✓ **Conditional Morphing Strategies:** Master conditional steps essential for executing full vehicle morphing.
- ✓ **Model Adaptability:** Acquire the skills to apply morphing methodologies to both CAD and FE models.
- ✓ **Design Line Justification:** Understand how to justify projection choices on all the design lines of the new vehicle.
- ✓ **Outcome Achievement:** Successfully produce a new EF vehicle design through the application of learned skills.



TARGETED AUDIENCE

CAD / CAE engineers who are involved in vehicle development and design, seeking to advance their skills in vehicle morphing for efficient design updates.



PREREQUISITE

Operational knowledge of DEP MeshWorks and its CAE Morphing capabilities (COMP-03 required)



DURATION

Flexible, adapted to client needs. Depending on the participants' existing background and the project scope.



TRAINERS

External expert *Sridhar Bijjala (DEP USA)*

SPE-03 Full Vehicle Morphing Mastery: Redefining Vehicle Design

Course detailed content

1. Foundational Training Phase: Mastering Vehicle Morphing Technologies

- ✓ Focus on key technologies essential for full vehicle morphing.
- ✓ Proportional modifications in CAD/CAE, dimensional changes in CAD while maintaining manufacturing constraints.
- ✓ Techniques for projecting onto CAD/CAE target design lines.

2. Supervision and Coaching Phase: Practical Application on a Pilot Project

- ✓ Hands-on supervision and coaching during a real pilot project, led by the trainer from the initial phase.
- ✓ Dual benefits: Applying concepts to a tangible project with expert on-site guidance and producing a new vehicle model using full vehicle morphing methodologies.

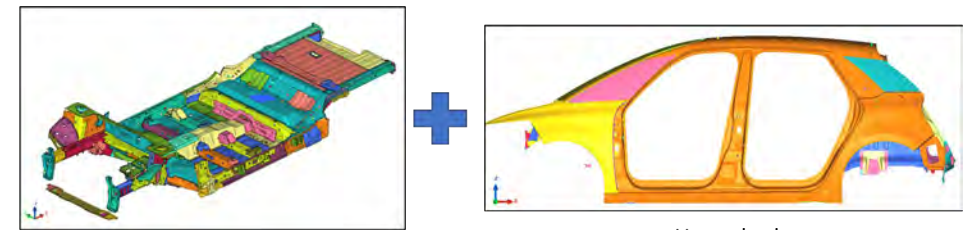
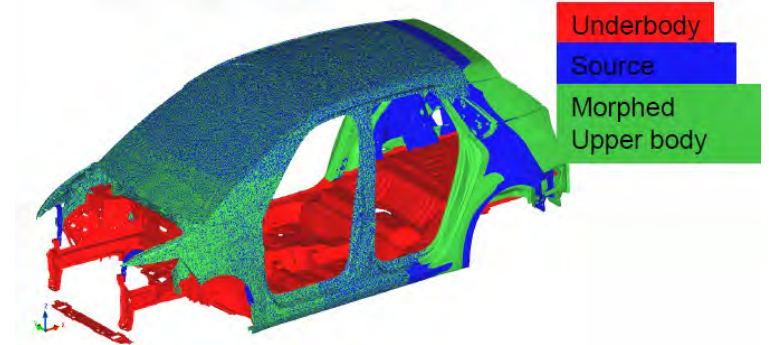

Under body (segregated)

Upper body

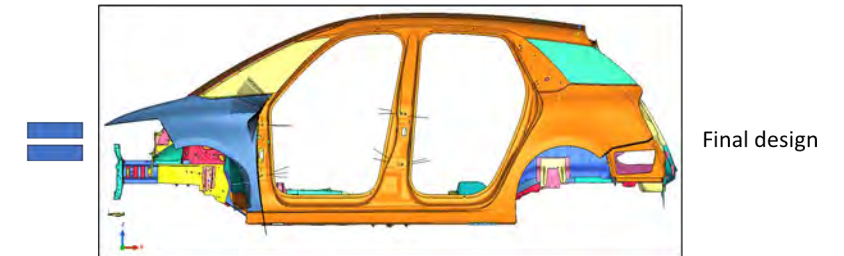

Final design

The key concepts of the training are illustrated with practical exercises.

- "Full Vehicle Morphing Mastery: Redefining Vehicle Design" offers a unique blend of theoretical learning and practical application. Participants will embark on a transformative journey, gaining hands-on experience in the latest vehicle morphing techniques and methodologies. The course culminates in a real-world pilot project, allowing trainees to apply their skills to actual vehicle design scenarios, guided by expert coaching.

SPE-04 Advanced Tire HEXA Meshing: Accelerating Tire Design



Course overview

1. Module Introduction and Automation Philosophy
2. Complex Part Workshop
3. Advanced Techniques and Parameterization

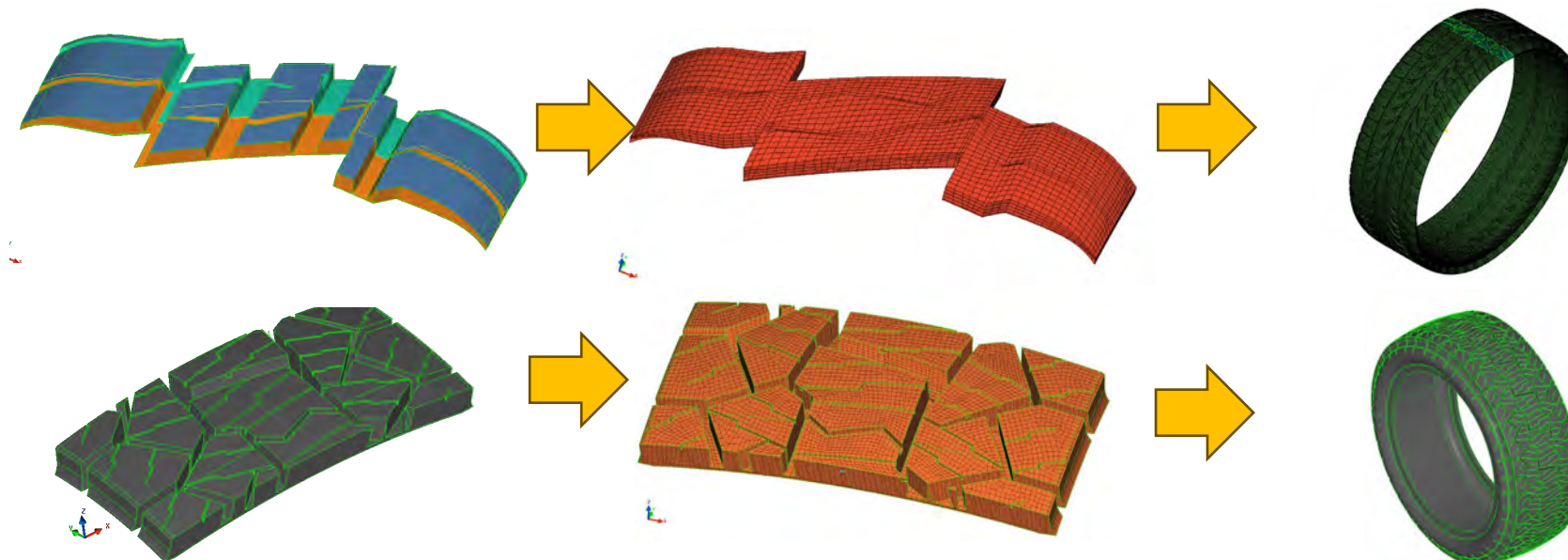

MAIN OBJECTIVE

- ✓ To enable participants to proficiently master the automated process of hexahedral meshing for tire treads, including setting up grooves for pattern optimization.

PEDAGOGICAL OBJECTIVES

- ✓ **Hexahedral Meshing Expertise:** Develop an in-depth understanding of semi-automated hexahedral meshing methods for tire applications.
- ✓ **Groove Pattern Implementation:** Learn to incorporate groove patterns within a tire section effectively.
- ✓ **Conditional Meshing Steps:** Acquire the skills to apply conditional steps for creating a high-quality hexahedral tire mesh.
- ✓ **Adaptability Across Tire Types:** Gain the ability to adapt these methods to a variety of tire designs.
- ✓ **Efficient Meshing Process:** Become proficient in quickly meshing tires using defined automated processes, enhancing productivity and accuracy.



TARGETED AUDIENCE

CAD / CAE engineers specializing in tire-related projects who aim to expedite their design and meshing processes.



PREREQUISITE

Operational knowledge of DEP MeshWorks with a focus on HEXA meshing (BAS-01H required). Familiarity with pneumatic applications.



DURATION

1 day



TRAINERS



SPE-04 Advanced Tire HEXA Meshing: Accelerating Tire Design

Course detailed content

1. Module Introduction and Automation Philosophy

- ✓ Understanding the module's purpose, benefits, and the philosophy behind its automation.
- ✓ Overview of the automated process steps for tire meshing.

2. Complex Part Workshop

- ✓ Hands-on workshop focusing on a complex tire part.
- ✓ Steps include: CAD import, cross-section creation, 2D meshing, HEXA mesh creation, groove identification, mesh pattern generation, and 360° repetition.

3. Advanced Techniques and Parameterization

- ✓ Exploring deeper into parameterization methods.
- ✓ Studying tire section variations for optimization.

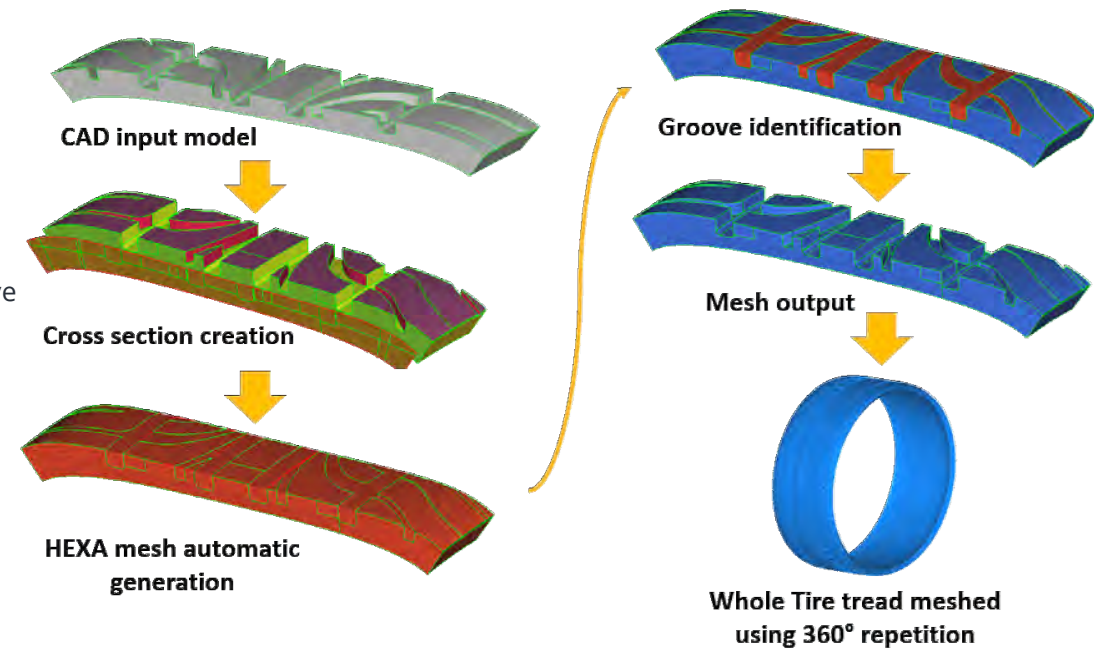

The key concepts of the training are illustrated with practical exercises.

- "Advanced Tire HEXA Meshing: Accelerating Tyre Design" is an essential course for CAE engineers in the tire industry, offering a blend of theoretical knowledge and practical skills. This course is a gateway to mastering efficient and innovative tire meshing techniques, significantly boosting design cycle efficiency and mesh quality.

SPE-05 Advanced Automated Features for Body, Chassis & Subframe



Course overview

1. Design Enablers for Body Structures
2. Vehicle Conversion and Weld Creation Tools
3. Feature Replication and Hemming Creation
4. Specialized Automation Tools for Body Structures

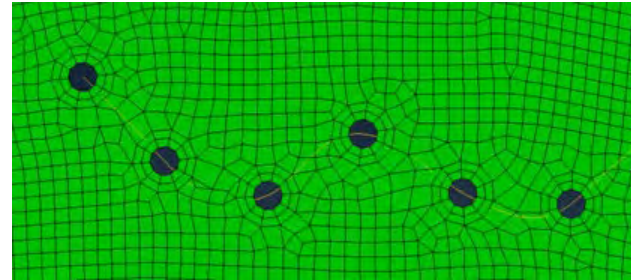

Penetration

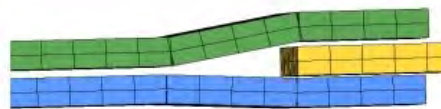

Gap

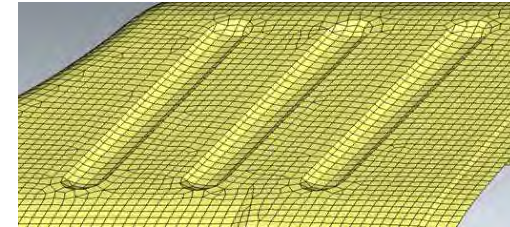
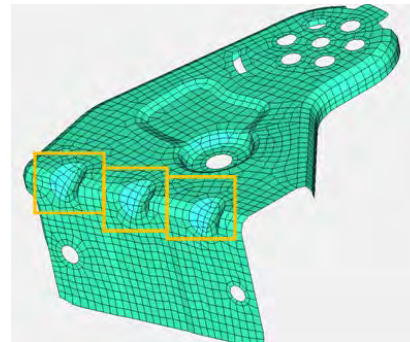

MAIN OBJECTIVE

- ✓ To empower participants with the advanced capabilities of MeshWorks focusing on design optimization, conversion tools, and specialized automation for crash and NVH scenarios.

PEDAGOGICAL OBJECTIVES

- ✓ **Advanced Design Skills:** Gain expertise in specific design enablers and reinforcement techniques unique to body structures.
- ✓ **Conversion and Welding Mastery:** Master the art of vehicle model conversion and sophisticated weld creation techniques.
- ✓ **Feature Replication Proficiency:** Learn to effectively replicate features for consistent design quality and efficiency.
- ✓ **Practical Automation and Setup:** Develop skills in using MeshWorks' automation tools for efficient setup of crash load cases and durable to NVH transitions.



TARGETED AUDIENCE

CAE engineers specializing in body, chassis, subframe design, particularly in crash and NVH applications, seeking advanced knowledge in MeshWorks.



PREREQUISITE

Advanced knowledge of DEP MeshWorks and ConceptWorks (SPE-01 required). Operational knowledge of body applications



DURATION

1 day



TRAINERS

External expert *Sridhar Bijjala (DEP USA)*

SPE-05 Advanced Automated Features for Body, Chassis & Subframe

Course detailed content

1. Design Enablers for Body Structures

- ✓ In-depth exploration of reinforcement techniques, including patches, component extensions, and LWB/TWB.
- ✓ Understanding the creation and application of crash initiators, holes, ribs, stiffeners, beads, and bosses in body structures.

2. Vehicle Conversion and Weld Creation Tools

- ✓ Mastery of the vehicle conversion tool for LS-Dyna to Nastran model transformation, including connection conversions.
- ✓ Proficiency in auto weld creation, part replacement, and auto flange adjustment.

3. Feature Replication and Hemming Creation

- ✓ Techniques for replicating components with constraints and connections.
- ✓ Detailed instruction on hemming mesh creation and rigid connection implementation.

4. Specialized Automation Tools for Body Structures

- ✓ Exploring the crash load cases setup automation, hood bead creation, and design space interior for body structures.
- ✓ Advanced modeling for chassis and subframes, including automated meshing and modeling as per solver templates.

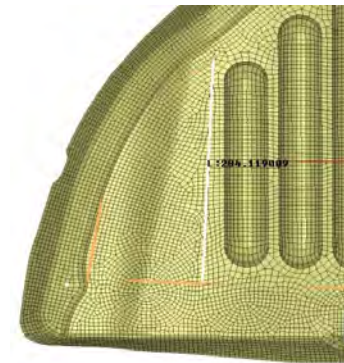
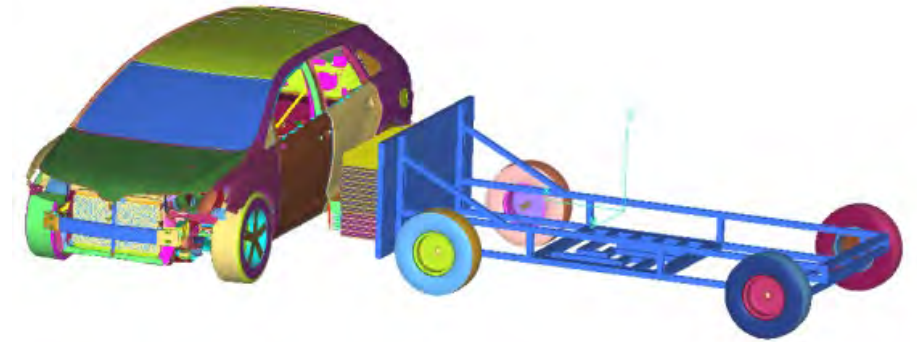

The key concepts of the training are illustrated with practical exercises.

- "Advanced Automated Features for Body Structures" is a targeted course that delves deep into the specialized tools and techniques of MeshWorks for body structure applications. Participants will come away with a nuanced understanding of MeshWorks' capabilities in reinforcing design processes, optimizing model conversions, and leveraging automation for efficient and effective body structures design.

SPE-06 Powertrain Engineering: Advanced Automation Techniques



Course overview

1. Optimized Design Definition for Powertrain Applications
2. Specialized Modelling and Meshing Automation
3. HEXA Automation and Complex Component Modelling
4. Advanced Welding and Connection Techniques
5. Innovative Automation for Component Replacement and Analysis

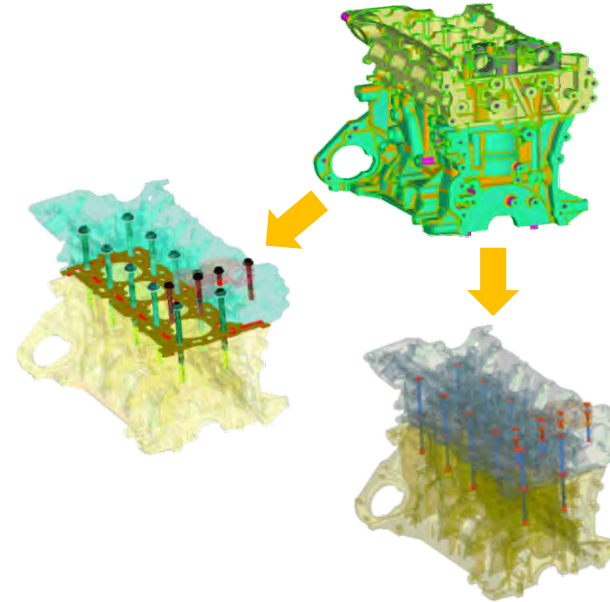
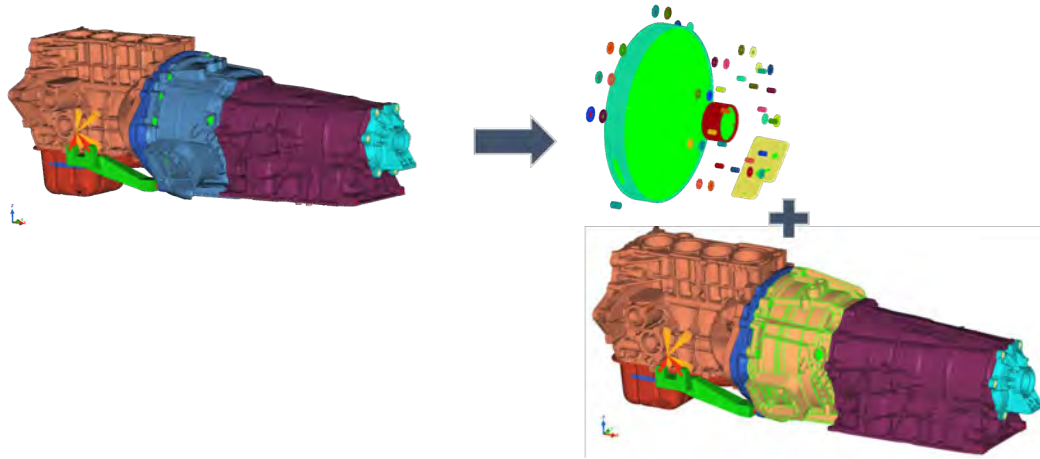

TARGETED AUDIENCE

CAE engineers in powertrain engineering and casting applications seeking to enhance their expertise in advanced automation techniques.



PREREQUISITE

Advanced knowledge of DEP MeshWorks (COMP-03 required). Operational knowledge of powertrain engineering.



DURATION

2 days



TRAINERS

External expert *Sridhar Bijjala (DEP USA)*

MAIN OBJECTIVE

- ✓ To enable participants to utilize MeshWorks' advanced automated features focusing on design optimization, specialized modeling, and automated processes specific to powertrain/casting applications.

PEDAGOGICAL OBJECTIVES

- ✓ **Design Optimization Mastery:** Develop skills in creating optimized, minimalistic powertrain designs using MeshWorks.
- ✓ **Modeling and Meshing Proficiency:** Gain expertise in automated meshing and modeling processes for key powertrain components.
- ✓ **Advanced Welding Techniques:** Learn to efficiently create complex weld connections, enhancing structural integrity in powertrain designs.
- ✓ **Component Automation and Analysis:** Master automated tools for component replacement and analysis, including bolt slippage and roller bearing modeling.
- ✓ **Practical Application:** Apply these advanced techniques in real-world powertrain engineering scenarios.

SPE-06 Powertrain Engineering: Advanced Automation Techniques

Course detailed content

1. Optimized Design Definition for Powertrain Applications

- ✓ Strategies for achieving minimalist powertrain designs.
- ✓ Techniques for design space creation, extension, and filling.
- ✓ Advanced methods for tetra rib and hole creation, and auto-parameterization in casting.

2. Specialized Modelling and Meshing Automation

- ✓ Crankshaft modeling for EHD, durability, and MBD to reduce time consumption.
- ✓ Automated conrod meshing, clutch meshing, and property assignment processes.

3. HEXA Automation and Complex Component Modelling

- ✓ HEXA automation for rotors, gears, pawls, bullets, pins, rods, etc.
- ✓ Specific tools for shaft modelling and 3D bolt match meshing.

4. Advanced Welding and Connection Techniques

- ✓ Creating slug and nugget weld connections efficiently.
- ✓ Weld joint creation for 3D weldment corners and roller bearing modelling.

5. Innovative Automation for Component Replacement and Analysis

- ✓ Stitch valve body tool and automated part replacement.
- ✓ Bolt slippage analysis and 1D to 3D bolt modeling techniques.

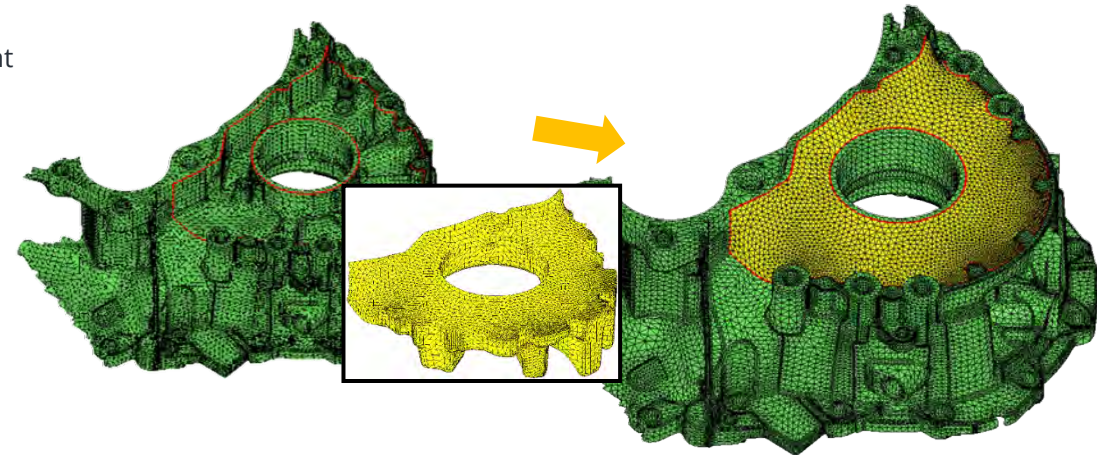

The key concepts of the training are illustrated with practical exercises.

- "Powertrain Engineering: Advanced Automation Techniques" is a specialized course designed for professionals in powertrain and casting applications. It offers an in-depth exploration of MeshWorks' advanced features, empowering participants to innovate and optimize their powertrain designs and processes with cutting-edge automation tools.



TRAINING CENTRE

Feature	INTER-company	INTRA-company	Customized/Specific	Remote via Videoconference
Participants	Up to 8	Up to 6	Tailored to client's needs	Up to 5
Location	Training centers	Client' site or training centers or remote	Client' site or training centers or remote	Any location with internet access
Schedule	Fixed (see Training Calendar)	Flexible (client preference)	Fully customized	Flexible and convenient
Content	Standard curriculum	Standard curriculum	Tailored to client's needs	Standard curriculum or Tailored to client's needs
Interaction	Mixed company participants	Employees from one company only	Direct focus on client's team and goals	Live remote interaction
Resources	Provided by DEP	Provided by client or DEP (depending on the location)	Provided by client or DEP (depending on the location)	Provided by client & software/licenses by DEP
Pricing	Per student	Fixed price for the group	Custom Fixed pricing based on the requirements	Fixed price for the group
Objective	Broad skill enhancement	Team-oriented learning	Specific objectives/targets	Accessible & flexible learning
Benefits	Network with peers, cost-effective	Privacy, convenience	Highly relevant, exclusive focus	Safe, no travel required
Ideal For	Individual growth, small companies	Team building, confidentiality	Specific challenges or projects	International teams, continuous learning

Read full terms and conditions



➤ Interested? Contact us at training@depeurope.com to build together a customized program that best meets your needs.

- **Request For Quotation:**



training@depeurope.com

+33 (0)5 61 44 54 98

- **Registration deadline**

One week at the latest before the start of the training, in order to send the convocations in good time.

- **Cancellation**

Only requests arriving no later than one week before the start of the training will be taken into account.

- **Training convention**

The invoice sent serves as a simplified professional convention (a separate convention can be shared on request).

- **Timings**

Except specific request, training begins at 9:00 am and ends around 6:00 pm

- **Language**

Training courses are taught in English or French and the course materials are available in English.

- **Invoicing and payment terms**

Training is charged at the end of the course and payable within 30 days of issue date of the invoice.



• Hygiene rules

Compliance with current legislation related to COVID or other pandemic is essential. As long as the health situation requires it, the following barrier gestures will be applied within the Dynas+ Engineering Products premises in order to preserve the health of all:

- Wash your hands regularly
- Cough or sneeze into your elbow or a tissue
- Use single-use tissues and throw them away
- Say 'hello' without shaking hands
- Respect physical distancing measures
- Aerate every 3 hours
- Regularly clean the materials handled
- Wear a mask in enclosed spaces

In addition, participants must comply with the regulations in force at the time of the course to be able to participate in the training. All registrations remain final and due.

• Exceptional cancellation

Depending on the evolution of the current health situation, Dynas+ Engineering Products reserves the right to cancel face-to-face training if it represents a risk for its employees.



• Technical and educational tools

- **Face-to-face:** The training includes a face-to-face class with a paper format documentation, also presented via video projector. In a general manner, it is associated with exercises carried out on a computer (provided by Dynas+ Engineering Products except for the training on customers' sites) in order to practice and get familiar with the software. An exercise paper book is then also provided. At the end of the training, the trainee can retrieve his digital work.
- **Videoconference:** The training includes a videoconference course accompanied by a password-protected pdf file sent by email beforehand. It is generally accompanied by computer-based exercises to help you get to grips with the software. In this case, a workbook in pdf format is also provided, and the corresponding data is sent via a secure exchange platform. The link to the WebEx[®] videoconferencing tool is sent directly to trainees before the start of the training session.

• Trainee evaluation methods

The trainee's attendance is controlled by signing an **attendance sheet**, per half-day of training. In addition, in order to assess his progress, an **initial evaluation sheet** is filled in by the trainee at the start of the training and a **trainer evaluation sheet** is completed by the trainer at the end of the training. Under request of the trainee, the latter can receive a **training certificate** provided that he has fulfilled all his obligations.

• Training evaluation methods

At the end of each training, the trainee is asked to complete a **training evaluation sheet** aimed at evaluating the quality of our training and improving it if necessary (technical level of the trainer, training material and support...).



• Quality Indicator

Further to each training provided by Dynas+ Engineering Products, the trainees are filling a "Training Assessment Form" allowing Dynas+ Engineering Products to assess the quality of the provided training. An indicator, based on this sheet, makes it possible to evaluate the level of customer satisfaction.

Seven criteria are considered:

- The technical level of the trainer,
- The pedagogic level of the trainer,
- The quality of the training progress,
- The quality of the training material,
- The quality of the exercises,
- The quality of the equipment,
- The quality of the training setup.

A grade between 1 and 4 is given to each of these criteria (4 being the best grade). The indicator includes all the training grades and makes the average over the last 6 months. The objective is to be greater than or equal to 3 for the whole year.

The figure below shows the results of the training quality indicator for the last full year:

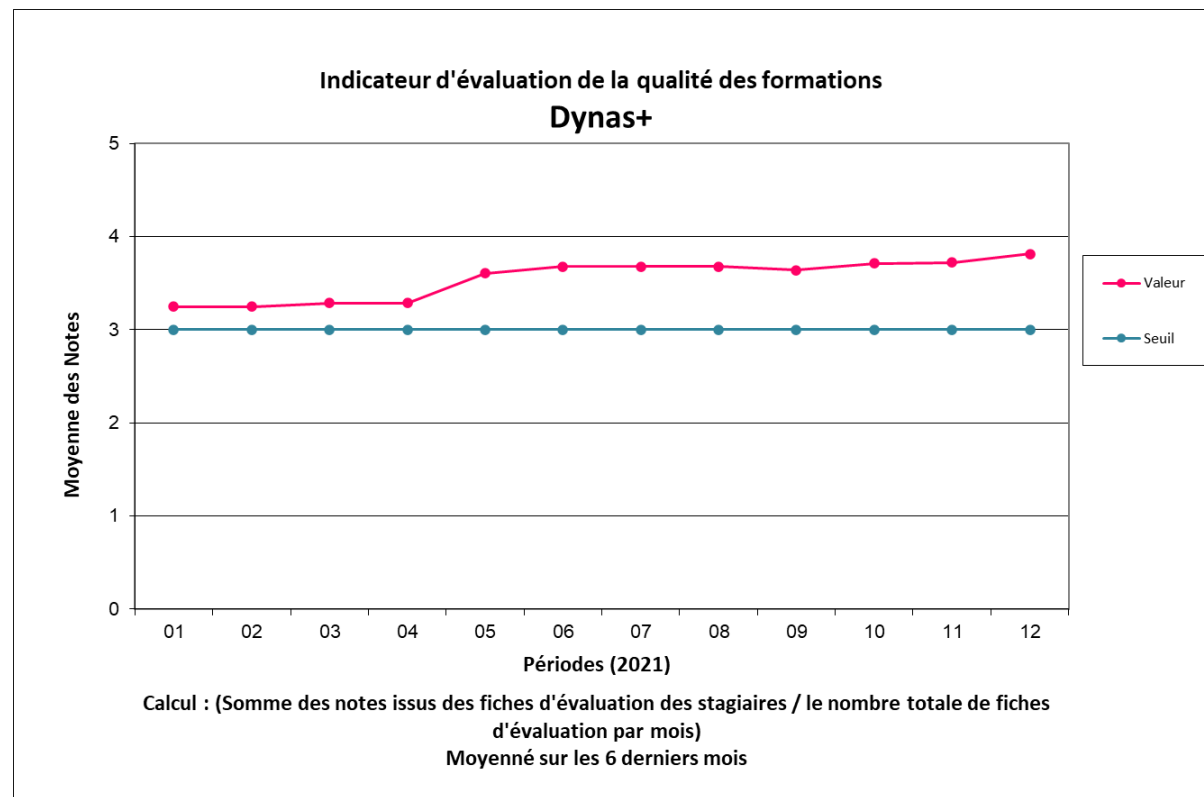





PRACTICAL INFORMATION





• **Address**

 5 avenue Didier Daurat
31400 Toulouse, FRANCE

• **Contact**

 training@depeurope.com
 +33 (0)5 61 44 54 98







• **Public transport**

Download the app 
Subway  Direction : « Ramonville » - Stop : « Faculté de Pharmacie »
Then Bus  Stop : « Clément Ader »

• **From the Toulouse Blagnac airport**

16 minutes ride (17 km)



-  **1 - Hôtel Ariane** ★★★★★
 30 rue des Cosmonautes 31400 TOULOUSE - ☎ 05 61 34 06 05 BUS **78** - 8 min
 Distance : 0.8 km - Site web : <http://www.hotelariane.com/>
-  **2 - Hôtel Ibis Style** ★★★★★
 120 rue Garance 31677 LABÈGE - ☎ 05 61 39 06 68 BUS **79** - 25 min
 Distance : 2.2 km - Site web : <https://all.accor.com/hotel/A0A2/index.fr.shtml>
-  **3 - Hôtel Le Sextant** ★★
 443 rue Découverte 31670 LABÈGE - ☎ 05 61 39 27 27 BUS **79** - 30 min
 Distance : 3.0 km - Site web : <http://www.hotelsextant.com/>
-  **4 - Hôtel Gril Campanile** ★★★★★
 342 rue Découverte 31670 LABÈGE - ☎ 05 61 39 83 83 BUS **79** - 30 min
 Distance : 3.0 km - Site web : <https://toulouse-sud-labege-innopole.campanile.com/fr-fr/>
-  **5 - Hôtel La Quietat** ★★★★★
 203 Route de Revel, 31400 TOULOUSE - ☎ 05 62 47 86 86 BUS **80** - 5 min
 Distance : 1.9 km - Site web : <http://http://www.hotel-la-quietat.fr/fr/>
-  **6 - Hôtel Ibis Style** ★★★★★
 21 avenue Marcel Dassault 31500 TOULOUSE - ☎ 05 61 80 18 01 BUS **37** - 8 min
 Distance : 1.7 km - Site web : <https://all.accor.com/hotel/7476/index.fr.shtml>
-  **Centre ville - Hôtel Ours Blanc** ★★
 14 place Victor Hugo 31000 TOULOUSE - ☎ 05 61 21 25 97
 Distance : 9.5 km - Site web : <http://www.hotel-oursblanc.com/index.php>

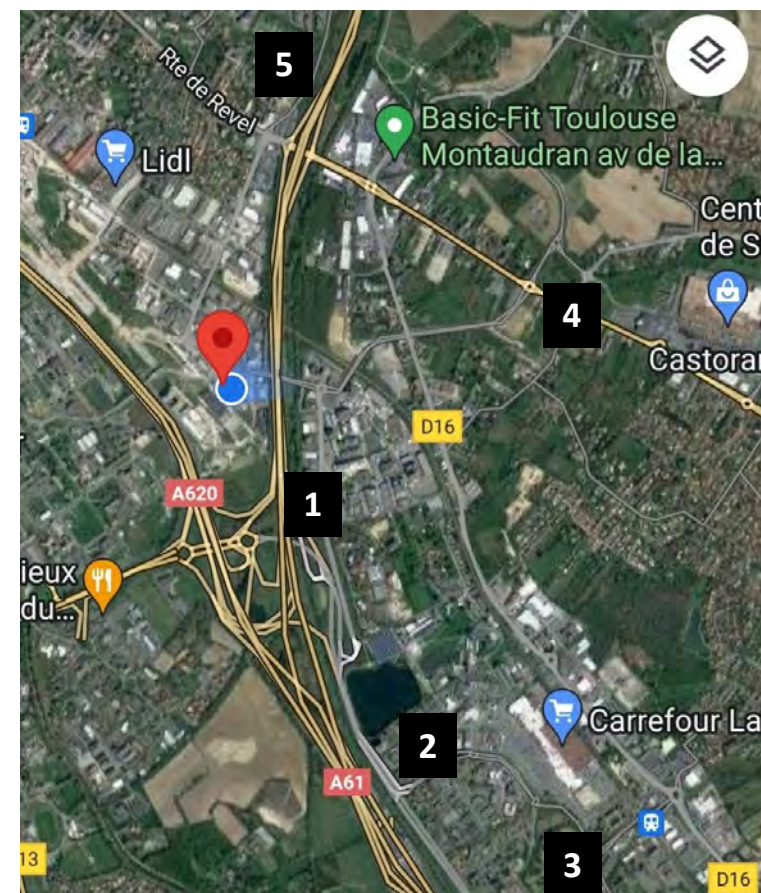

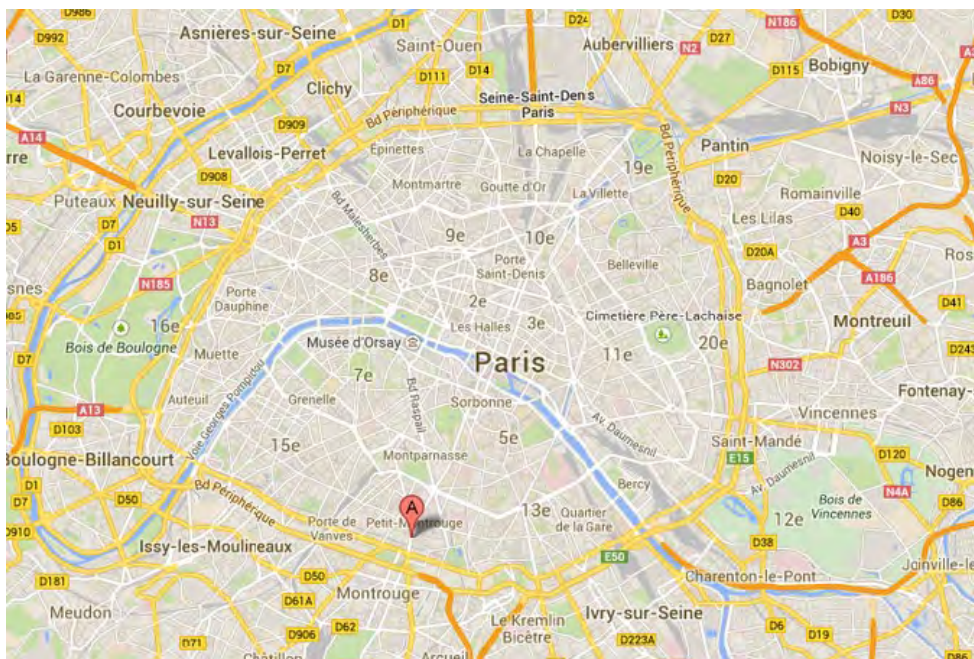

• **Adress**

 99bis Avenue du général Leclerc
74014 Paris, FRANCE

• **Contact**

 training@depeurope.com

 +33 (0)5 61 44 54 98

• **By subway**

 Station « Alésia » ou « Porte d'Orléans »



• **By tramway**

 Station « Porte d'Orléans »



CONTACT US

LICENSES

licenses@depeurope.com

SUPPORT

support@depeurope.com

TRAINING

training@depeurope.com

SALES

email@depeurope.com